

# FM/AM Clock Radio ICF-C1iP

## Operating Instructions

# DREAM MACHINE

Dream Machine is a trademark of Sony Corporation.



No Power No Problem is a trademark of Sony Corporation.

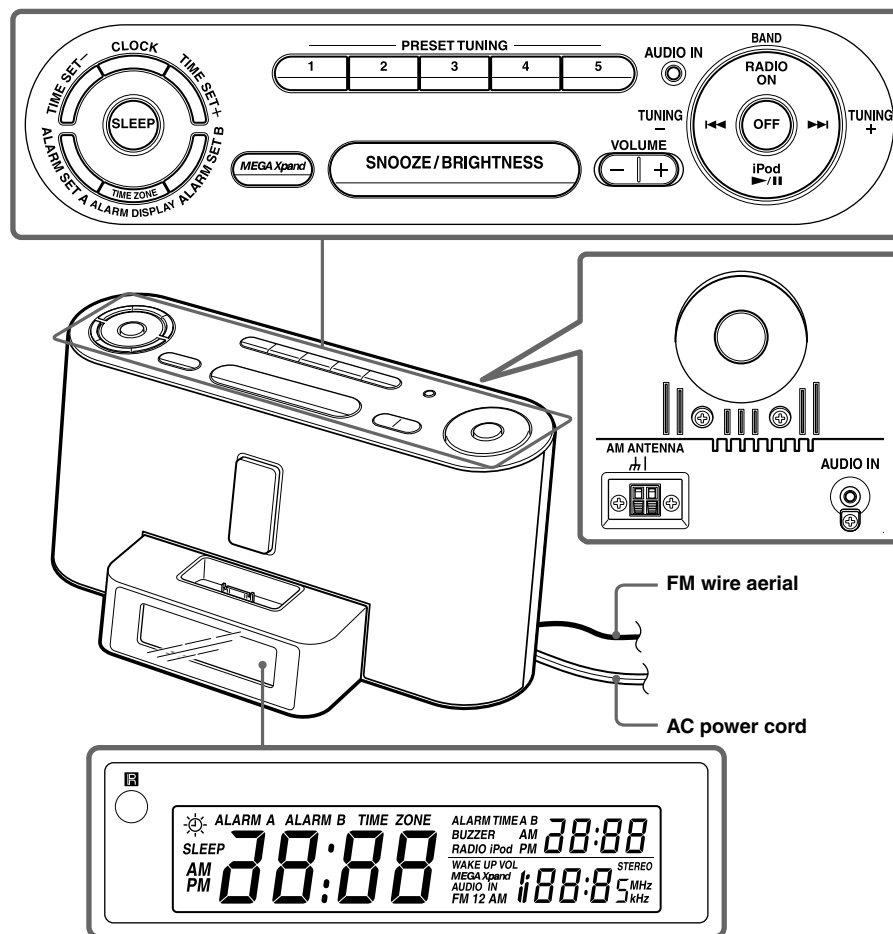

There is a tactile dot on the VOLUME +, ►/II and PRESET TUNING 3 button.

**A**

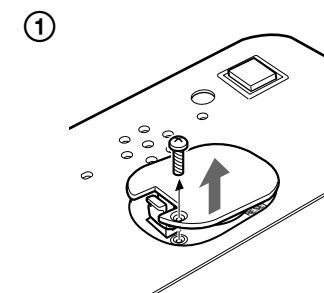

**2**

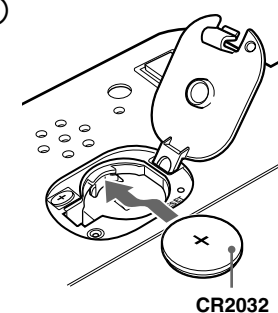

**3**

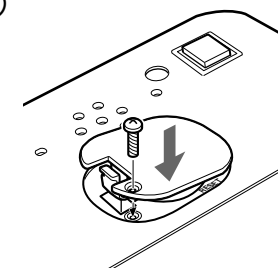

**B**

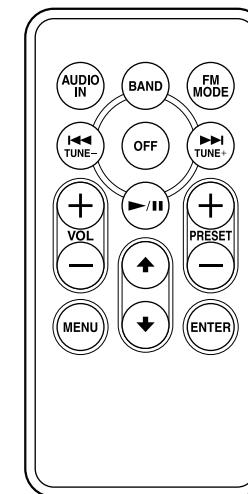

There is a tactile dot on the VOL +, ►/II, ↑ and PRESET + button.

**1**

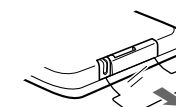

**2**

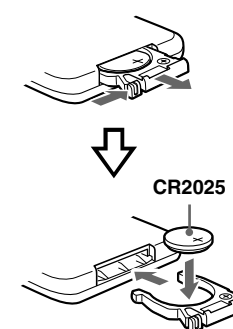

© 2007 Sony Corporation Printed in China

## WARNING

To reduce the risk of fire or electric shock, do not expose this apparatus to rain or moisture.

To reduce the risk of fire, do not cover the ventilation of the apparatus with newspapers, tablecloths, curtains, etc. And do not place lighted candles on the apparatus.

The apparatus shall not be exposed to dripping or splashing and no objects filled with liquids, such as vases, shall be placed on the apparatus.

Do not install the appliance in a confined space, such as a bookcase or built-in cabinet.

As the main plug is used to disconnect the unit from the mains, connect the unit to an easily accessible AC outlet. Should you notice an abnormality in the unit, disconnect the main plug from the AC outlet immediately.

**Notice for customers: the following information is only applicable to equipment sold in countries applying EU directives**

The manufacturer of this product is Sony Corporation, 1-7-1 Konan, Minato-ku, Tokyo, Japan. The Authorized Representative for EMC and product safety is Sony Deutschland GmbH, Hedelfinger Strasse 61, 70327 Stuttgart, Germany. For any service or guarantee matters please refer to the addresses given in separate service or guarantee documents.

## WARNING

- Danger of explosion if battery is incorrectly replaced. Replace only with the same or equivalent type.
- Replace the battery for the clock backup with a Sony CR2032 lithium battery, and the battery for the remote commander with a Sony CR2025 lithium battery. Use of another battery may present a risk of fire or explosion.
- Battery may explode if mistreated. Do not recharge, disassemble or dispose of in fire.
- Do not expose the batteries (battery pack or batteries installed) to excessive heat such as sunshine, fire or the like for a long time.
- Dispose of used battery promptly. Keep away from children.

## Precautions

- Operate the unit on the power source specified in "Specifications".
- To disconnect the power cord (mains lead), pull it out by the plug, not the cord.
- The unit is not disconnected from the AC power source (mains) as long as it is connected to the wall outlet, even if the unit itself has been turned off.
- Allow adequate air circulation to prevent internal heat build-up. Do not place the unit on a surface (a rug, blanket, etc.) or near materials (a curtain) that might block the ventilation holes.
- Should any solid object or liquid fall into the unit, unplug the unit and have it checked by a qualified personnel before operating it any further.
- To clean the casing, use a soft cloth dampened with a mild detergent solution.
- Do not connect the aerial lead to the external aerial.
- To reduce the risk of fire, do not cover the ventilation of the apparatus with newspapers, tablecloths, curtains, etc. And do not place lighted candles on the apparatus.

### NOTES ON LITHIUM BATTERY

- Wipe the battery with a dry cloth to assure a good contact.
- Be sure to observe the correct polarity when installing the battery.
- Do not hold the battery with metallic tweezers, otherwise a short-circuit may occur.



**Disposal of Old Electrical & Electronic Equipment (Applicable in the European Union and other European countries with separate collection systems)**

This symbol on the product or on its packaging indicates that this product shall not be treated as household waste. Instead it shall be handed over to the applicable collection point for the recycling of electrical and electronic equipment. By ensuring this product is disposed of correctly, you will help prevent potential negative consequences for the environment and human health, which could otherwise be caused by inappropriate waste handling of this product. The recycling of materials will help to conserve natural resources. For more detailed information about recycling of this product, please contact your local Civic Office, your household waste disposal service or the shop where you purchased the product.



**Disposal of waste batteries (applicable in the European Union and other European countries with separate collection systems)**

This symbol on the battery or on the packaging indicates that the battery provided with this product shall not be treated as household waste.

On certain batteries this symbol might be used in combination with a chemical symbol. The chemical symbols for mercury (Hg) or lead (Pb) are added if the battery contains more than 0.0005% mercury or 0.004% lead.

By ensuring these batteries are disposed of correctly, you will help prevent potentially negative consequences for the environment and human health which could otherwise be caused by inappropriate waste handling of the battery. The recycling of the materials will help to conserve natural resources.

In case of products that for safety, performance or data integrity reasons require a permanent connection with an incorporated battery, this battery should be replaced by qualified service staff only. To ensure that the battery will be treated properly, hand over the product at end-of-life to the applicable collection point for the recycling of electrical and electronic equipment.

For all other batteries, please view the section on how to remove the battery from the product safely. Hand the battery over to the applicable collection point for the recycling of waste batteries.

For more detailed information about recycling of this product or battery, please contact your local Civic Office, your household waste disposal service or the shop where you purchased the product.

**If you have any questions or problems concerning your unit, please consult your nearest Sony dealer.**

## Features

- Dual alarm FM/AM Clock radio with iPod dock.
- Various type of alarms- iPod, radio and buzzer.
- Automatic time set — When you plug the clock in for the first time, the current time will be shown in the display.
- Automatic Daylight Saving Time/Summer time adjustment.
- CLOCK button to display month, day and year.
- Brightness control (High/Middle/Low).
- No Power No Problem™ alarm system to keep the clock and the alarm operating during a power interruption with a CR2032 battery installed.

## Connecting the aerial

**To connect the AM loop aerial**

The shape and the length of the aerial is designed to receive AM signals. Do not dismantle or roll up the aerial.

- 1 Remove only the loop part from the plastic stand.
- 2 Set up the AM loop aerial.

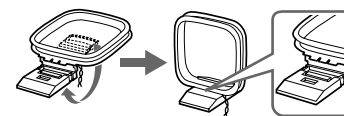

- 3 Connect the cords to the AM aerial terminals.

The cords (A and B) can be connected to either terminal.

**Insert the cord while pushing down the terminal clamp.**

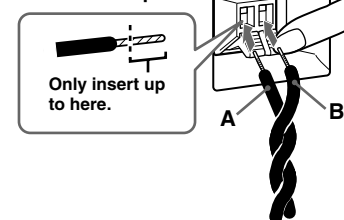

- 4 Make sure the AM loop aerial is connected firmly by pulling softly.

### Adjusting the AM loop aerial

Find a place and an orientation that provide good reception.

- Do not place the AM loop aerial near the unit or other AV equipment, as noise may result.
- If you use an external polarized AM aerial, be sure to connect the ground cord to the ⚡ terminal. The supplied AM aerial cord has no polarity.

### Tip

Adjust the direction of the AM loop aerial for best AM broadcast sound.

## About the backup battery

To keep good time, as a backup power source, this unit has one CR2032 battery inside of the unit in addition to the house current.

The battery keeps the clock and the alarm operating in the event of a power interruption. Note that the backlight will not light up during a power interruption.

### Knowing when to replace the battery

If a power interruption occurs when the battery is weak, the brightness of characters in the display darkens. If the battery runs out during the interruption, the current time and alarm functions will be initialized.

Replace the battery with a Sony CR2032 lithium battery. Use of another battery may present a risk of fire or explosion.

### Replacing the backup battery

- 1 Keep the AC plug connected to the AC outlet, remove the screw that secures the battery compartment at the bottom of the unit using a screwdriver, and remove the battery compartment. (See Fig. A-①)
- 2 Insert a new battery in the battery compartment with the ⊕ side facing up. To remove the battery from the battery compartment, push it out from the side marked PUSH. (See Fig. A-②)
- 3 Insert the battery compartment back into the unit and secure it with the screw. (See Fig. A-③)

### Notes

When you replace the battery, keep the AC plug connected to a wall outlet. Otherwise, current time and alarms will be initialized if the replacement is not completed within around one minute.

## If the time in the display is incorrect after the battery is changed (RESET)

Push the Reset switch with the pointed device. The Reset switch is in the small hole located in the battery compartment.

### Notes

- You cannot reset unless the lithium battery is installed.
- Set the clock again after the unit is reset.

### Battery Warning

When the unit will be left unplugged for a long time, remove the battery to avoid undue battery discharge and damage to the unit from battery leakage.

## Preparing the remote commander

Before using the card remote commander for the first time, remove the insulation film. (See Fig. B-①)

### When to replace the battery

With normal use, the battery (CR2025) should last for about six months. When the remote commander no longer operates the unit, replace the battery with new ones. (See Fig. B-②)

### Notes

- Do not charge the battery.
- When you are not going to use the remote commander for a long time, remove the battery to avoid any damage caused by leakage and corrosion.

## Setting the clock for the first time

This unit is preset to the current date and time at the factory, and is powered by the back up battery. All you need to do the first time is just plug it in and select your time zone.

- Plug in the unit.
- Press **TIME ZONE** for more than two seconds. Area number “3” appears in the display. If you live in the Western European Time zone, you do not need to adjust the area setting.

| Area number | Time zone  |
|-------------|--|
| 1           | Eastern European Time/Eastern European Summer Time |
| 2           | Central European Time/Central European Summer Time |
| 3           | Western European Time/Western European Summer Time |

- Press **TIME SET +** or **–** repeatedly until the desired number appears.
- Press **TIME ZONE** to complete the setting.

**Note**

- During the shipment and your first use, a clock error may occur. In this case, refer to “Setting the clock and date” to set the correct time.
- The area number is set to 3 at the factory, but if the unit is reset, the area number is changed to 2. When you use the unit in a Western European time zone, change the area number to 3. And set the time again (see “Setting the clock and date”).

### When daylight saving time (summer time) begins

This model employs the Automatic Daylight Saving Time/Summer Time adjustment. The DST indicator in the display appears in the display at the beginning of the daylight saving time (summer time), and disappears at the end of it. Automatic DST/Summer Time adjustment is based on GMT (Greenwich Mean Time).

- Summer time begins at: 1:00 AM on the final Sunday of March.
- Standard time begins at: 2:00 AM on the final Sunday of October.

### To deactivate the Automatic DST/Summer Time adjustment during the daylight saving time (summer time) period.

The Automatic DST/Summer Time adjustment can be cancelled. Press **CLOCK** and **TIME ZONE/ALARM DISPLAY** for more than two seconds. The Automatic DST/ Summer Time adjustment will be cancelled. To active the Automatic DST/Summer Time adjustment again, repeat the same operation.

## Setting the clock and date

To change the setting manually, follow the procedure from step **1**.

- Press **CLOCK** for more than 2 seconds. The year will start to flash in the display.
- Press **TIME SET +** or **–** until the correct year appears in the display.
- Press **CLOCK**.
- Repeat steps **2** and **3** to set the month, day and time. After setting the minute the clock starts from 0 seconds. But if you do not set “Minute”, the clock does not start from 0 second flat.

- Pressing and holding **+** or **–** changes the year, month, day or time rapidly.
- While setting the clock, you must perform each step within about 65 seconds, or the clock setting mode will be cancelled.

### To display the year and date

Press **CLOCK** once for the date, and within about 5 seconds press it again for the year. The display shows the date or year for about 5 seconds and then changes back to the current time.

## Setting the brightness of the display

Three levels of brightness are available by pressing **SNOOZE/BRIGHTNESS**.

High (default) → Middle → Low

## Operating the iPod

You can enjoy iPod audio by connecting this unit. To use an iPod, refer to the user’s guide of your iPod.

### Compatible iPod models

The compatible iPod models are as follows. Update your iPod to use the latest software before you use it.

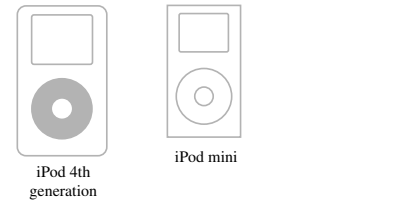
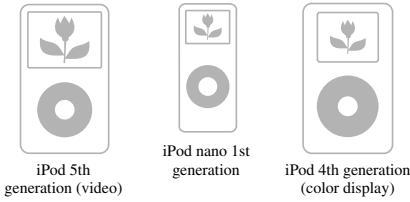
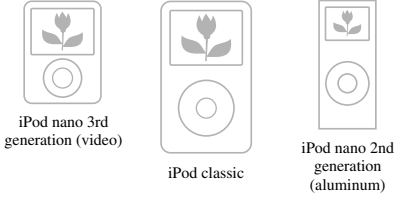
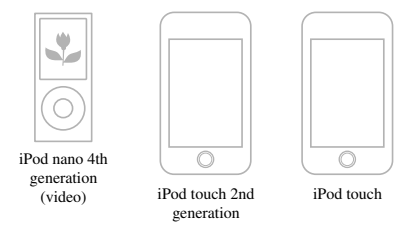

**Notes**

- The connector of the unit is for sole use for iPod. When you use the devices do not match with the connector, connect it to the **AUDIO IN** terminal of this unit with the supplied audio connecting cable.
- Sony cannot accept responsibility in the event that data recorded to iPod is lost or damaged when using an iPod connected to this unit.

- Put the iPod into the unit’s connector.

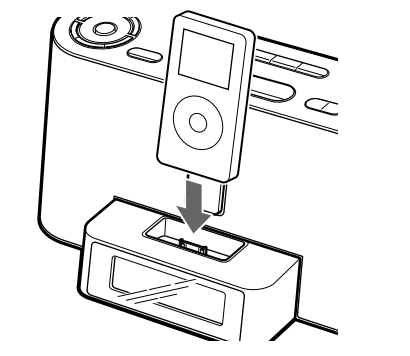

Adjust the rear support forward or backward checking the back of the iPod fits snugly against the rear support to protect the connector.

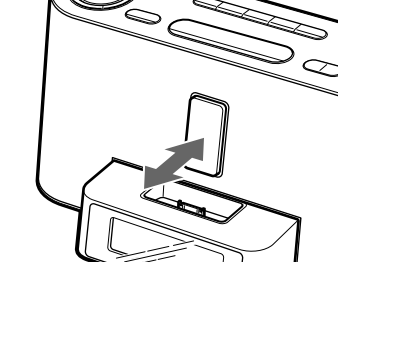
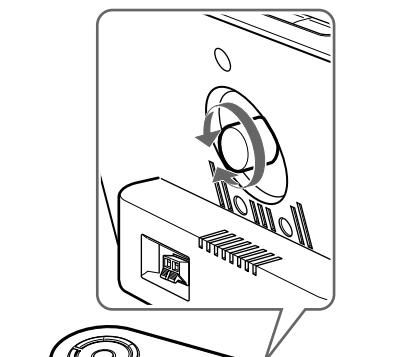

- Press **▶/II**. The iPod begins to play automatically. You can operate the connected iPod by the unit or iPod buttons.

| To   | Press   |
|--|---|
| Turn off the iPod                                | <b>OFF</b> , or press and hold <b>▶II</b>   |
| Pause playback                                   | <b>▶/II</b><br>To resume play, press it again.  |
| Go to the next track                             | <b>▶▶</b>   |
| Go back to the previous track                    | <b>◀◀</b>   |
| Locate a point while listening to the sound      | <b>▶▶</b> (forward) or <b>◀◀</b> (backward) while playing and hold it until you find the point. |
| Locate a point while observing the previous menu | <b>▶▶</b> (forward) or <b>◀◀</b> (backward) in pause and hold it until you find the point.      |
| Go back to the previous menu                     | <b>MENU*</b>  |
| Select a menu item or a track for playback       | <b>↑/↓*</b>   |
| Execute the selected menu or the playback        | <b>ENTER*</b>   |

\* These operations are available only when using the supplied remote commander.

**Notes**

- When placing or removing the iPod, keep it straight and parallel with the rear support.
- Do not carry the unit with an iPod set on the connector. Doing so may cause a malfunction.
- When placing or removing the iPod, brace the unit with one hand and take care not to press the controls of the iPod by mistake.
- Do not pull on the rear support strongly as it cannot be detached from the unit and may cause a malfunction.
- To use an iPod, refer to the user’s guide of your iPod.
- Before disconnecting the iPod, pause playback.

**Tip**

Apple’s iPod Universal Dock Adapter can be used with this unit.

### To use the unit as a battery charger

You can use the unit as a battery charger. The charging begins when the iPod is placed on the connector. The charging status appears in the iPod display. For details, see the user’s guide of your iPod.

### On copyrights

- iPod is a trademark of Apple Inc., registered in the U.S. and other countries.
- All other trademarks and registered trademarks are of their respective holders. In this manual, ™ and ® marks are not specified.

## Operating the radio —Manual tuning

- Press **RADIO ON** to turn on the radio. The display shows the band and frequency.



- Press **RADIO ON** repeatedly to select the desired band. Each press changes the band as follows:

FM1 → FM2 → AM

FM1 and FM2 are the same frequency bands.

- Use **TUNING +** or **–** to tune into the desired station. The FM frequency advances or reverses in 0.1 MHz channel steps and the AM frequency in 10 kHz channel steps.

- Adjust volume using **VOLUME**. To turn off the radio, press **OFF**.

## Improving the reception

**FM:** Extend the FM wire aerial fully to increase reception sensitivity.

**AM:** Connect the supplied AM loop aerial to the unit. Rotate the aerial horizontally for optimum reception.

Keep away iPod from the AM loop aerial or the FM wire aerial, as this may lead to interference of reception.

**Tip**

If the FM broadcast is noisy, press **FM MODE** on the remote commander to turn off “STEREO” in the display. The radio becomes clearer although the sound becomes monaural.

## Presetting your favourite station —Preset tuning

You can preset up to 10 stations in FM (5 stations in FM1, 5 stations in FM2), and 5 stations in AM.

### Presetting a station

- Follow steps **1** to **4** in “Operating the Radio” and manually tune into the station you wish to preset.
- Press and hold the desired **PRESET TUNING** button for more than two seconds for registration. After the preset has finished, the preset number appears on the display.

**Example:** To preset AM 1 260 kHz onto preset **2** button.

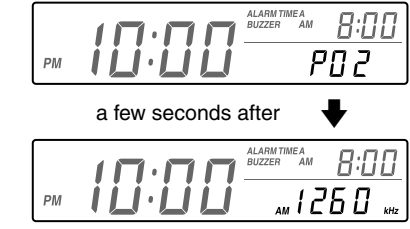

To preset another station, repeat these steps. To change the preset station, tune into the desired station and hold down the **PRESET TUNING 1** to **5** button. The new station will replace the previous station on the preset button.

### Tuning into a preset station

- Press **RADIO ON** to turn on the radio.
- Press one of the **PRESET TUNING** buttons where the desired station is stored.
- Adjust volume using **VOLUME**.

## Setting the alarm

The dual alarm function allows you to set two alarm programs (ALARM A and ALARM B). The alarm time can be set for each program and the alarm sound is selectable from RADIO, BUZZER or iPod.

**Notes**

- Before setting the alarm, make sure to set the clock (see “Setting the clock and date”).
- The factory setting alarm time is “AM 12:00”.
- To set the radio alarm, first tune in to a station (see “Operating the radio”).

### To set the alarm time

To set **ALARM A**

- Press **ALARM SET A** for a few seconds.
- Press **TIME SET +/-** to set the desired hour, and press **ALARM SET A**.
- Press **TIME SET +/-** to set the desired minute, and press **ALARM SET A**.
- Press **TIME SET +/-** to set the desired alarm mode (RADIO, BUZZER or iPod) and press **ALARM SET A**.
- If you select the RADIO or iPod, press **TIME SET +/-** to set the wake up volume and press **ALARM SET A**.

To set **ALARM B**, follow the same steps above using **ALARM B** instead of **ALARM A**.

To change the display between **ALARM TIME A** and **ALARM TIME B**, press **TIME ZONE/ALARM DISPLAY**.

**When using iPod touch**

To use music stored in an iPod touch to wake up, put the iPod touch into the unit first, follow the steps above to set alarm time, and then select the desired music.

**Notes**

- When you use the radio alarm, the timed alarm sounds with the last broadcasting station tuned to before the power went off. When you set the radio alarm, select the desired broadcasting station before turning the power off.
- The **ALARM A** (or **B**) indicator flashes in the display when the alarm sounds.
- If a second alarm sounds during a first (or the **SNOOZE** function is active), the second alarm takes priority.
- The alarm function works as usual at the beginning and end day of the daylight saving time (summer time). While the Automatic DST/Summer Time adjustment is set, as a result, if the alarm is set at a time skipped when the daylight saving time (summer time) begins, the alarm is skipped, or if the alarm is set at a time overlapped when the daylight saving time (summer time) ends, the alarm sounds twice.
- If the same alarm time is set for both alarm (ALARM A and B), the ALARM A takes priority.

### To activate the alarm

After setting the alarm time, follow these steps: To activate the **ALARM A**, press **ALARM SET A** to display **ALARM A**.

To activate the **ALARM B**, press **ALARM SET B** to display **ALARM B**.

**Notes**

- The alarm sounds at the set time even if the unit is on.
- Make sure the iPod is installed correctly after setting the iPod alarm.

**Notes on using iPod touch**

- If you set the iPod alarm while iPod touch music is playing, and then turn the unit power off, when the alarm time comes on, the alarm music will resume from the point where the power was turned off.
- Even if the iPod alarm setting is complete, if you turn the iPod touch power off before the unit, the iPod alarm will not work.

### To doze for a few more minutes

Press **SNOOZE/BRIGHTNESS**. The sound turns off but will automatically come on again after about 5 minutes. The maximum length of the snooze time is 40 minutes.

### To stop the alarm

Press **OFF** to turn off the alarm. The alarm will come on sound again at the same time the next day. If **OFF** is not pressed, the buzzer alarm sounds continuously for about 3 minutes, and then it stops automatically. The RADIO and iPod sound continuously until **OFF** is pressed.

### To deactivate the alarm

Press **ALARM SET A** (or **B**) to turn off the **ALARM A** (or **B**) indicator from the display.

**Note on alarm in the event of a power interruption**

- When the alarm sound is set to RADIO or iPod, it will change to **BUZZER** automatically.
- If the backup battery is exhausted, the alarm will not work in the event of power interruption. Replace the battery periodically.

## Setting the sleep timer

You can fall asleep to the sound using the built-in sleep timer that turns off the unit automatically after a preset duration.

- Press **SLEEP** while the unit is turned on. SLEEP appears in the display.
- Press **SLEEP** to set the sleep timer duration. Each time you press **SLEEP**, the duration changes as follows:

90 → 60 → 30 → 15  
└ OFF ─┘

The display returns to clock mode five seconds after you have finished setting the duration setting and released **SLEEP**, and then the sleep timer starts. The unit will play for the duration you set, and then shut off.

### To turn off the unit before the preset time

Press **OFF**.

### To use both sleep timer and alarm

You can fall asleep to the radio and also be awakened by the radio or buzzer alarm at the preset time.

- Set the alarm. (See “Setting the alarm”.)
- Set the sleep timer. (See “Setting the sleep timer”.)

## Other useful functions

### To get the MEGA Xpand effect

Press **MEGA Xpand**. “MEGA Xpand” appears in the display. You can get the effect of expansion of the sound field. To return to normal sound, press the button again.

## Connecting external equipment

### To listen to sound

- Connect the **AUDIO IN** jack of the unit to the line out jack or headphone jack of the external equipment using the audio connecting cable (supplied).

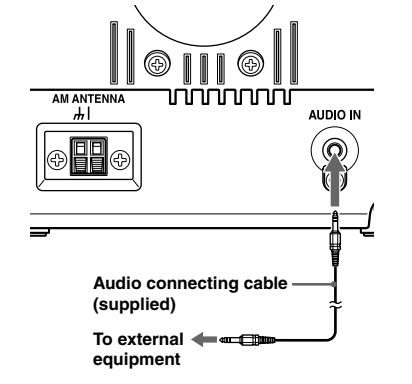

- Press **AUDIO IN** to display “AUDIO IN”.
- Play the equipment connected to the **AUDIO IN** jack.
- Adjust the volume using **VOLUME**.

### To return to the radio

Press **RADIO ON**.

The frequency is shown in the display.

### To return to the iPod

Press **▶/II**.

### To stop listening

Press **OFF**, and stop playback on the connected unit.

## Troubleshooting

Should any problem occur with the unit, make the following simple checks to determine whether or not servicing is required. If the problem persists, consult your nearest Sony dealer.

**The clock displays “AM 12:00” due to a power interruption.**

- The battery is low. Replace the battery. Remove the old battery and install a new one.

**When daylight saving time begins, the clock does not employ the daylight saving time automatically.**

- Make sure the clock is set correctly.
- Press and hold **CLOCK** and **TIME ZONE/ALARM DISPLAY** simultaneously for at least two seconds to employ the DST function.

**The alarm does not sound at the preset alarm time.**

- Has the desired alarm been activated? (i.e., Does the **ALARM A** (or **B**) indicator light up?)

**The radio or iPod alarm is activated but no sound comes on at the preset alarm time.**

- Has **VOLUME** been adjusted?

**There is no sound from the iPod.**

- Make sure the iPod is securely connected.
- Adjust the **VOLUME**.

**The iPod cannot be operated with this unit.**

- Make sure the iPod is securely connected.

**The iPod cannot be charged.**

- Make sure the iPod is securely connected.

## Specifications

| <b>Time display</b>    | 12-hour System  |              |
|------------------------|-----------------|--------------|
| <b>Frequency range</b> |                 |              |
| Band                   | Frequency       | Channel step |
| FM                     | 87.5 – 108 MHz  | 0.05 MHz     |
| AM                     | 531 – 1 602 kHz | 9 kHz        |

|                             |   |
|-----------------------------|---|
| <b>Speaker</b>              | Approx. 5.1 cm (2 inches) dia., 12 Ω  |
| <b>Power output</b>         | 3 W + 3 W (at 10% harmonic distortion)  |
| <b>Power requirements</b>   | 230 V AC, 50 Hz<br>For clock backup: 3 V DC, one CR2032 battery   |
| <b>Dimensions</b>           | Approx. 300 × 130 × 139 mm (w/h/d)<br>(11 <sup>13</sup> / <sub>16</sub> × 5 <sup>1</sup> / <sub>8</sub> × 5 <sup>1</sup> / <sub>2</sub> inches) incl. projecting parts and controls |
| <b>Mass</b>                 | Approx. 1.9 kg (4 lb 3.02 oz) incl. CR2032 battery  |
| <b>Supplied accessories</b> | Remote commander (1)<br>Audio connecting cable (1)<br>AM loop aerial (1)  |

Design and specifications are subject to change without notice.