

# ***Video Cassette Recorder***

---

Operating Instructions



**VIDEO***plus+*

***SLV-E230UY/EY***

## WARNING

To prevent fire or shock hazard, do not expose the unit to rain or moisture.

To avoid electrical shock, do not open the cabinet. Refer servicing to qualified personnel only.

Mains lead must be changed only at qualified service shop.

## NOTICE for the customers in the United Kingdom

A moulded plug complying with BS 1363 is fitted to this equipment for your safety and convenience.

Should the fuse in the plug supplied need to be replaced, a 5 AMP fuse approved by ASTA or BSI to BS 1362, (i.e. marked with 2 or @ mark) must be used.

If the plug supplied with this equipment has a detachable fuse cover, be sure to attach the fuse cover after you change the fuse. Never use the plug without the fuse cover. If you should lose the fuse cover, please contact your nearest Sony service station.

## Precautions

### Safety

- Check that the unit's operating voltage is identical with your local power supply. The unit operates on 220 – 240V AC, 50Hz.
- If anything falls into the cabinet, unplug the unit and have it checked by qualified personnel before operating it any further.
- The unit is not disconnected from the mains as long as it is connected to the mains outlet, even if the unit itself has been turned off.
- Unplug the unit from the mains outlet if you do not intend to use it for an extended period of time. To disconnect the cord, pull it out by the plug, never by the cord.

### Installing

- Allow adequate air circulation to prevent internal heat buildup.
- Do not place the unit on surfaces (rugs, blankets, etc.) or near materials (curtains, draperies) that may block the ventilation slots.
- Do not install the unit near heat sources such as radiators or air ducts, or in a place subject to direct sunlight, excessive dust, mechanical vibration or shock.

- Do not install the unit in an inclined position. It is designed to be operated in a horizontal position only.
- Keep the unit and cassettes away from equipment with strong magnets, such as microwave ovens or large loudspeakers.
- Do not place heavy objects on the unit.
- If the unit is brought directly from a cold to a warm location, moisture may condense inside the VCR and cause damage to the video head and tape. When you first install the unit, or when you move it from a cold to a warm location, wait for about one hour before operating the unit.

### Caution

Television programmes, films, video tapes and other materials may be copyrighted. Unauthorized recording of such material may be contrary to the provisions of the copyright laws. Also, use of this recorder with cable television transmission may require authorization from the cable television transmitter and/or programme owner.

### Compatible colour systems

This VCR is designed to record and play back using the PAL colour system. Recording of video sources based on other colour systems cannot be guaranteed.

---

# Table of contents

---

## Getting Started

- 4 Step 1: Unpacking
  - 5 Step 2: Setting up the remote commander
  - 7 Step 3: Connecting the VCR
  - 8 Step 4: Setting up the VCR with the Auto Set Up function
  - 9 Step 5: Tuning your TV to the VCR
  - 11 Step 6: Setting the clock
  - 13 Manual setup —
    - Selecting a language, Presetting channels, Setting up VIDEO Plus+\*
  - 21 Setting your personal code
- 

## Basic Operations

- 23 Playing a tape
- 25 Recording TV programmes
- 28 Recording TV programmes using VIDEO Plus+
- 31 Setting the timer manually

## Additional Information

- 43 Troubleshooting
- 46 Specifications
- 47 Index to parts and controls
- Back cover
- Index

## Additional Operations

- 34 Playing/searching at various speeds
- 35 Recording TV programmes using the quick timer
- 36 Checking/changing/cancelling timer settings
- 38 Adjusting the picture
- 39 Changing menu options
- 41 Editing with another VCR

\* VIDEO Plus+ and PlusCode are trademarks applied for by Gemstar Development Corp. VIDEO Plus+ system is manufactured under license from Gemstar Development Corporation.

# Step 1

## Unpacking

Check that you have received the following items with the VCR:

- Remote commander

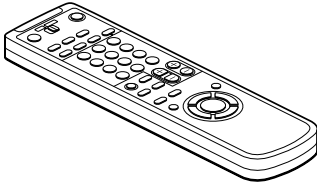

- Aerial cable

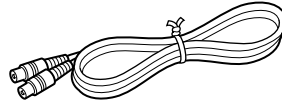

- R6 (size AA) batteries

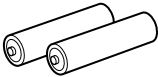

### Checking your model name

The instructions in this manual are for the 2 models : SLV-E230UY, and E230EY. Check your model number by looking at the rear panel of your VCR. The SLV-E230UY is the model used for illustration purposes. Any difference in operation is clearly indicated in the text, for example, "SLV-E230EY only."

## Step 2

# Setting up the remote commander

### Inserting the batteries

Insert two R6 (size AA) batteries by matching the + and - on the batteries to the diagram inside the battery compartment.

Insert the negative (-) end first, then push in and down until the positive (+) end clicks into the position.

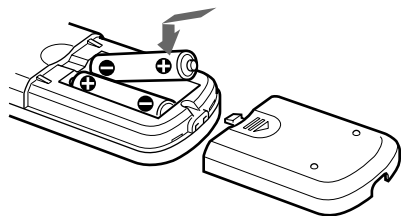

### Using the remote commander

You can use this remote commander to operate this VCR and a Sony TV. Buttons on the remote commander marked with a dot (•) can be used to operate your Sony TV.

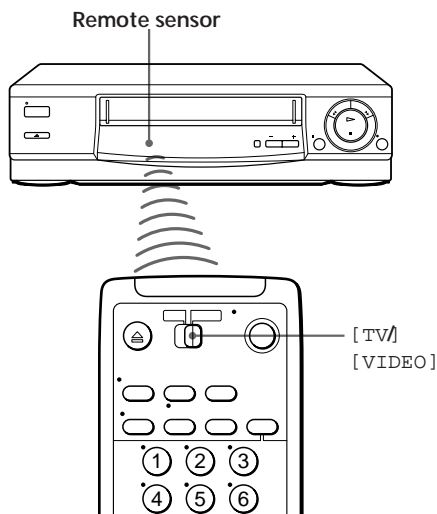

To operate the VCR	Set [TV] [VIDEO] to [VIDEO] and point at the remote sensor on the VCR
a Sony TV	[TV] and point at the remote sensor on the TV

continued

## Step 2 : Setting up the remote commander (continued)

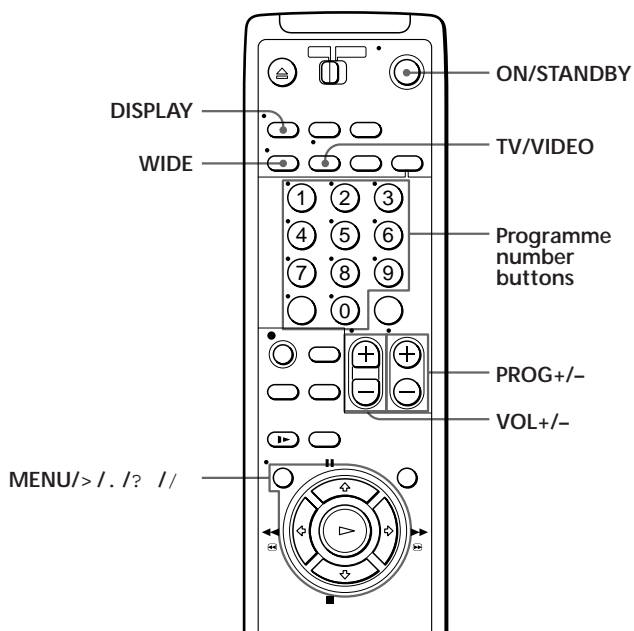

### TV control buttons

To	Press
Turn the TV into standby or active mode	ON/STANDBY
Select an input source of the TV either from aerial in or from line in	TV/VIDEO
Select the programme position of the TV	Programme number buttons PROG +/-
Adjust the volume of the TV	VOL +/-
Call up on-screen display	DISPLAY
Operate TV menu options	MENU/> / . / ? //
Switch the wide mode of a Sony wide TV	WIDE

### Notes

- With normal use, the batteries should last about three to six months.
- If you do not use the remote commander for an extended period of time, remove the batteries to avoid possible damage from battery leakage.
- Do not use a new battery with an old one.
- Do not use different types of batteries.
- Some buttons may not work with certain Sony TVs.

## Step 3

# Connecting the VCR

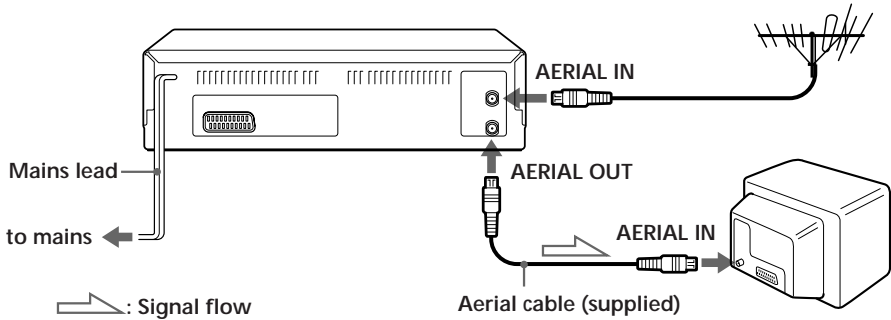

1

Disconnect the aerial cable from your TV and connect it to AERIAL IN on the rear panel of the VCR.

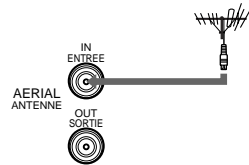

2

Connect AERIAL OUT of the VCR and the aerial input of your TV using the supplied aerial cable.

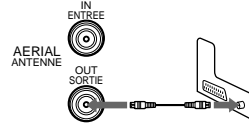

3

Connect the mains lead to the mains.

## Additional connection

To a TV that has a EURO-AV (Scart) connector

This additional connection improves picture and sound quality. Connect the TV as shown on the right. Whenever you want to watch the VCR picture, press TV/VIDEO to display the VIDEO indicator in the display window.

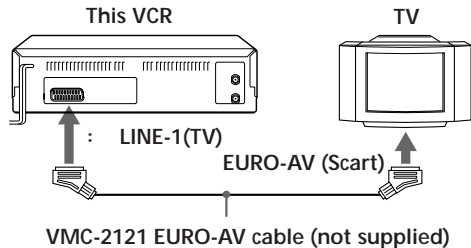

### Note

- When you connect the VCR and your TV only with an aerial cable, you have to set RF MODULATOR in the OPTIONS menu to ON (initial setting). If the TV is connected to the LINE-1(TV) connector, setting RF MODULATOR in the OPTIONS menu to OFF is recommended. In the OFF position, only the signal from the aerial is output through the AERIAL OUT connector (see page 39).

## Step 4

# Setting up the VCR with the Auto Set Up function

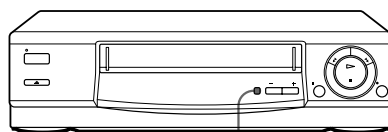

AUTO SET UP

Before using the VCR for the first time, set up the VCR using the Auto Set Up function. With this function, you can set TV channels, guided by the sequence indicated in the display window.



Hold down AUTO SET UP on the VCR for more than three seconds. The ATP (Auto Tuner Preset) function starts searching for all of the receivable channels.

When no more receivable channels can be found, presetting stops and "SET UP" disappears from the display window.

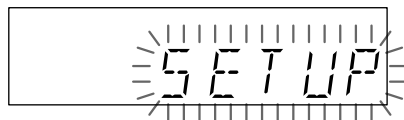

### To cancel the Auto Set Up function

Press AUTO SET UP.

#### Tips

- If you want to change the language for the on-screen display from English, see page 13.
- If you want to change the programme positions, see page 14.
- To set the guide channels for VIDEO Plus +, see page 17.

#### Note

- Do not cancel the Auto Set Up function during the ATP operations. If you do, repeat the step above.



## Step 5

### Tuning your TV to the VCR

If you connect the VCR to your TV using the EURO-AV cable, skip this step.

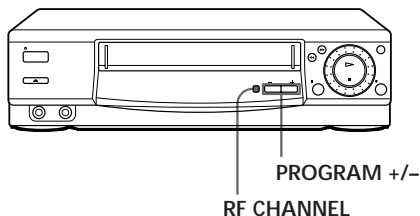

**1** AUTO SET UP  
RF CHANNEL

Press RF CHANNEL on the VCR.

The RF channel appears in the display window.

The VCR signal is output through this channel to the TV.

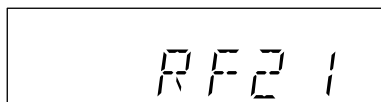

**2**

Turn on your TV and select a programme position for the VCR picture.

This programme position will now be referred to as the video channel.

**3**

Tune the TV to the same channel as that shown in the display window so that the picture on the right appears on the TV screen.

Refer to your TV manual for tuning instructions.

If the picture does not appear clearly, see "To obtain a clear picture from the VCR" on page 10.

SONY VIDEO CASSETTE  
RECORDER

**4**

AUTO SET UP  
RF CHANNEL

Press RF CHANNEL.

You have now tuned your TV to the VCR. Whenever you want to play a tape, set the TV to the video channel.

continued

---

## **Step 5 : Tuning your TV to the VCR (continued)**

**To check to see if the TV tuning is correct**

Set the TV to the video channel and press PROGRAM +/- on the VCR. If the TV screen changes to a different programme each time you press PROGRAM +/-, the TV tuning is correct.

**To obtain a clear picture from the VCR**

If the picture does not appear clearly in step 3 above, go to step 4 to finish this procedure once. Then start from step 1. After pressing RF CHANNEL in step 1 to display the RF channel, press PROGRAM +/- so that another RF channel appears. Then tune the TV to the new RF channel until a clear picture appears.

# Step 6

## Setting the clock

You must set the time and date on the VCR to use the timer recording features properly.

Before you start...

- Turn on the VCR and the TV.
- Set the TV to the video channel.

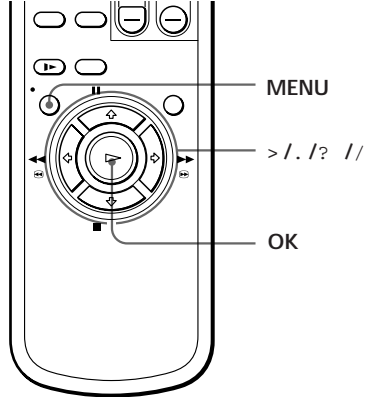

### Setting the clock manually

**1** • MENU

Press MENU, then press > / . to select SETTINGS and press OK.

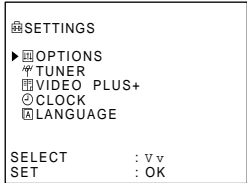
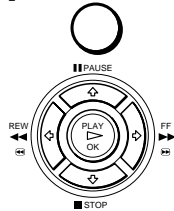

**2**

Press > / . to select CLOCK and press OK.

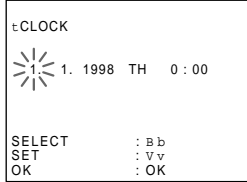
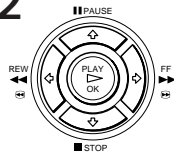

**3**

Press > / . to set the date.

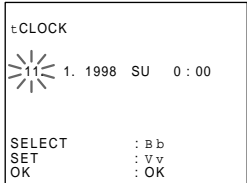
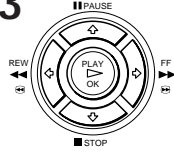

continued

## Step 6 : Setting the clock (continued)

4

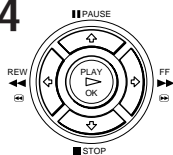

Press / to flash the month and set the month using > / . .

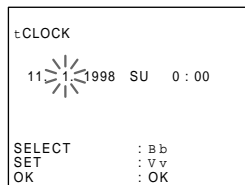

5

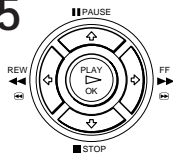

Set the year, hour, and minutes in sequence, using / to flash the item to be set, and press > / . to select the digits. The day of the week is set automatically.

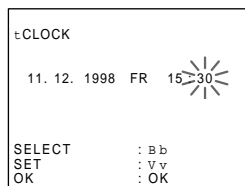

6

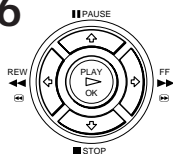

Press / to start the clock.

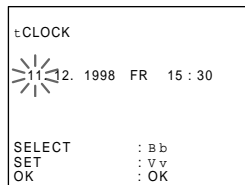

7

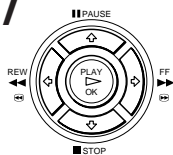

Press OK.

### Tip

- To change the digits during setting, press ? to return to the item to be changed, and select the digits using > / . .

### Note

- The menu disappears automatically if you don't proceed for more than a few minutes.

# Manual setup — Selecting a language

You can change the on-screen display language.

Before you start...

- Turn on the VCR and the TV.
- Set the TV to the video channel.

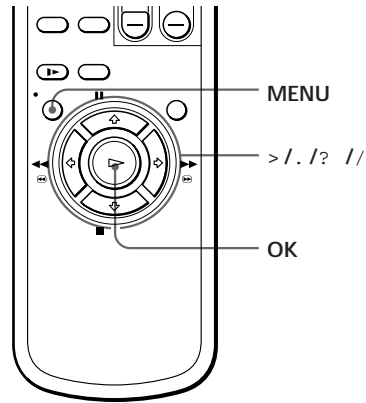

## 1

• MENU



Press MENU, then press > / . to select SETTINGS and press OK.

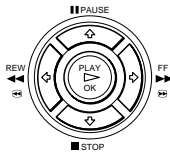

SETTINGS	
▶ OPTIONS	
⚙ TUNER	
VIDEO PLUS+	
CLOCK	
LANGUAGE	
SELECT	: V V
SET	: OK

## 2

Press > / . to select LANGUAGE, then press OK.

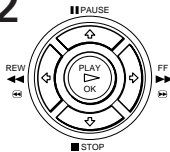

LANGUAGE	
• ENGLISH	NEDERLANDS
DEUTSCH	DANSK
FRANÇAIS	SVENSKA
ITALIANO	SUOMI
ESPAÑOL	ΕΛΛΗΝΙΚΑ
PORTUGUÉS	
SELECT	: V V
SET	: OK

## 3

Press > / . / ? // to move the dot (•) to the desired language, then press OK.

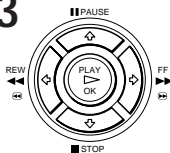

# Manual setup — Presetting channels

If some channels could not be preset using the Auto Set Up function, you can preset them manually.

Before you start...

- Turn on the VCR and the TV.
- Set the TV to the video channel.

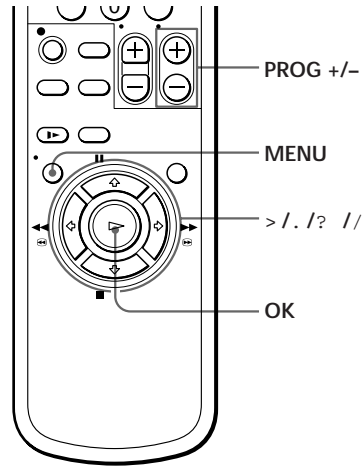

- 1** • **MENU** Press MENU, then press > / . to select SETTINGS and press OK.

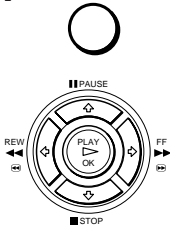

⊞	SETTINGS	
▶	⊞	OPTIONS
	⊞	TUNER
	⊞	VIDEO PLUS+
	⊞	CLOCK
	⊞	LANGUAGE
SELECT	:	V v
SET	:	OK

- 2** Press > / . to select TUNER, then press OK.

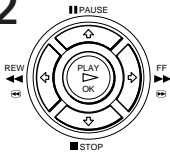

⊞	TUNER	PROG14
▶	⊞	CHANNEL SET
		[C23 ]
		BBC1
	AFT	[ON ]
	FINE TUNING	
SELECT	:	V v
SET	:	B b

- 3** (SLV-E230EY only) Press > / . to move the cursor ( ) to NORMAL/CATV, then select either NORM or CATV using ? // .

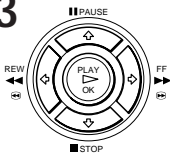

⊞	TUNER	PROG14
▶	⊞	NORMAL/CATV
		[NORM]
		CHANNEL SET
		[C23 ]
	AFT	[ON ]
	FINE TUNING	
SELECT	:	V v
SET	:	B b

4

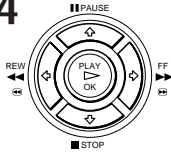

Press > / . to move the cursor ( ) to CHANNEL SET.

#TUNER	PROG14
▶CHANNEL SET	[C23 ]
AFT	BBC1
FINE TUNING	[ON ]
SELECT	: V v
SET	: B b

5

•PROG

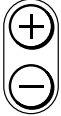

Press PROG +/- to select the programme position.

Selected programme position

#TUNER	PROG 7
▶CHANNEL SET	[C23 ]
AFT	BBC1
FINE TUNING	[ON ]
SELECT	: V v
SET	: B b

6

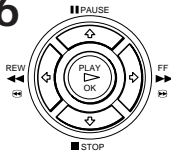

Press ? // repeatedly until the channel you want is displayed.

The channels appear in the following order:

SLV-E230UY  
• UHF B21 - B69

SLV-230EY  
• VHF A - J  
• UHF B21 - B69  
• CATV S1 - S20  
• HYPER S21 - S41  
• CATV S01 - S05

If you know the number of the channel you want, press the programme number buttons. For example, for channel 5, first press "0" and then press "5."

#TUNER	PROG 7
▶CHANNEL SET	[C41 ]
AFT	ITV
FINE TUNING	[ON ]
SELECT	: V v
SET	: B b

7

To allocate another channel to another programme position, repeat steps 3 to 6.

8

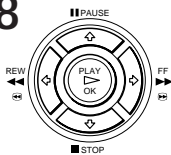

Press OK.

### Disabling unwanted programme positions

After presetting the channels, you can disable unused programme positions. The disabled positions will be skipped later when you press the PROG +/- buttons.

- 1 In step 6 above, press programme number button “0” twice to display the number “00” beside CHANNEL SET.
- 2 Press OK.

### If the picture is not clear

Normally, the Auto Fine Tuning (AFT) function automatically tunes in channels clearly. If, however, the picture is not clear, you may also use the manual tuning function.

- 1 Press PROG +/- to select the programme position for which you cannot obtain a clear picture.
- 2 Press MENU, then select SETTINGS and press OK.
- 3 Select TUNER and press OK.
- 4 Select FINE TUNING. The fine tuning meter appears.

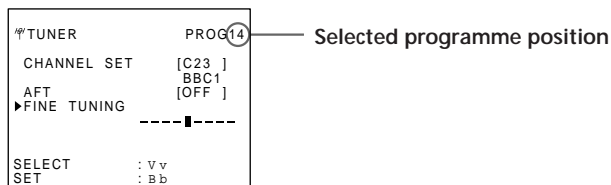

- 5 Press ? // to get a clearer picture, then press OK.  
Note that the AFT (Auto Fine Tuning) setting switches to OFF.

#### Note

- The menu disappears automatically if you don't proceed for more than a few minutes.



# Manual setup — Setting up VIDEO Plus+

VIDEO Plus+ is a feature that simplifies programming the VCR to make timer recordings. To use VIDEO Plus+, each programme position needs to be matched with its VIDEO Plus+ guide channel. To get the guide channel numbers, see “Guide channels for VIDEO Plus+” on page 19, or look in the programme guide for your area that features PlusCode.

- If you want to record satellite broadcasts using VIDEO Plus+, see page 20.

### Before you start...

- Turn on the VCR and the TV.
- Set the TV to the video channel.

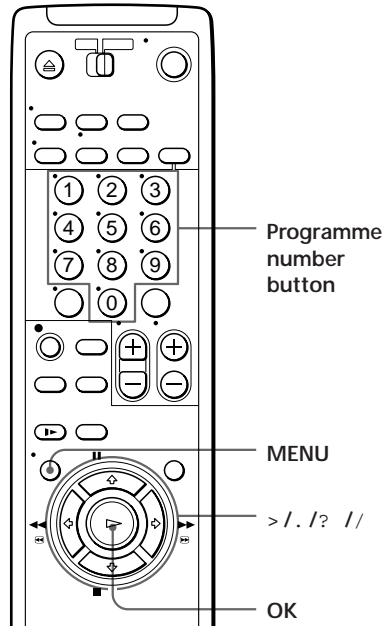

## 1 • MENU

Press MENU, then press > / . to select SETTINGS and press OK.

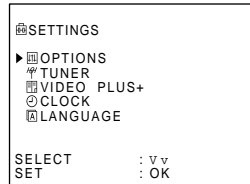
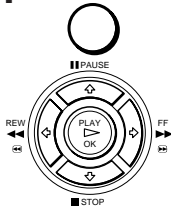

## 2

Press > / . to select VIDEO PLUS+ and press OK.

The preset channels are displayed on the screen. “- - -” in the GUIDE CH column means that the guide channel has not been preset.

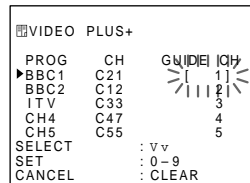
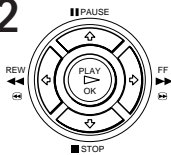

continued

## Manual setup — Setting up VIDEO Plus+ (continued)

3

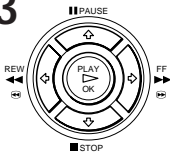

Press > / . to move the cursor ( ) to the row on which you want to set the guide channel.

To display other pages for programme positions 6 to 60, press > / . repeatedly.

SHOWVIEW		
PROG	CH	GUIDE CH
6	C01	---
7	C02	++++
▶ 8	C03	++++
9		----
10	C15	----
SELECT	: V v	
SET	: 0-9	
CANCEL	: CLEAR	

4

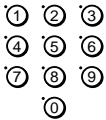

Press programme number buttons to enter the guide channel number assigned in the programme guide.

SHOWVIEW		
PROG	CH	GUIDE CH
6	C01	---
7	C02	++++
▶ 8	C03	1234
9		----
10	C15	----
SELECT	: V v	
SET	: 0-9	
CANCEL	: CLEAR	

5

To set the guide channel of another station, repeat steps 3 to 4.

6

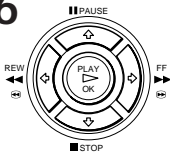

Press OK.

## Guide channels for VIDEO Plus+

Guide channel	Station name	Guide channel	Station name
001	BBC1	125	BRAVO
002	BBC2		HSND
003	ITV		EBN
004	CHANNEL 4	126	CNN
005	CHANNEL 5	127	EURONEWS
006	RTE 1	128	PERFORMANCE
007	RTE 2		THE ARTS CHANNEL
008	TV NA GAELTACHTA	129	SKY MOVIES GOLD
101	SKY ONE		WEATHER
102	SKY NEWS	130	UK LIVING
103	SKY MOVIES		TELEVISION X FANTASY
104	THE MOVIE CHANNEL		CHANNEL
105	SKY SPORT	131	GRANADA +
106	NICKELODEON	132	GRANADA TALK
	PARAMOUNT CHANNEL	132	SKY SCOTTISH
107	EUROSPORT	133	TV5 EUROPE
	QUANTOM TV	134	TVE INTERNATIONAL
108	WARNER BROTHERS	135	MBC
109	MTV EUROPE		ARABIC
110	CHILDREN'S CHANNEL	136	QVC
	THE FAMLY CHANNEL	137	SPORTNET
111	THE DISNEY CHANNEL	138	COUNTRY MUSIC TV
112	BBC WORLD SERVICE		JAPANESE TV
113	RTL 4	140	SKY SPORT 2 & SOAPS &
114	FILMNET 2		TRAVEL & HIST & SF
	SUPER SPORT	141	TV ASIA
	ADULT CHAN	142	GRANADA GOOD LIFE
115	RTL PLUS INTERNATIONAL	142	GRANADA TV HIGH STREET
116	SAT 1	142	GRANADA FOOD + WINE
117	PREMIERE	142	GRANADA HEALTH AND
118	3 SAT		BEAUTY
119	SKY 2	142	GRANADA HOME + GARDEN
119	FOX KIDS	143	LIVE TV
120	PRO 7	144	SUPERCHANNEL
121	TELE 5	145	VIDEO HITS ONE
122	TELECLUB		VH-1 (ENGLISH)
123	UK GOLD	146	SELECT TV
124	TLC	147	FILMNET 1 (24 HOUR)
	DISCOVERY	148	SKY SPORT 3
	REGAL SHOP		PLAYBOY TV
		149	TNT
			CARTOON NETWORK

## Note

- The guide channel codes listed above are as of 20 February 1997. If you have any questions about the guide channels, please consult your nearest Sony service facility or the marketing group of Sony UK.

continued

### Setting up VIDEO Plus+ for satellite broadcasts

When your satellite tuner is connected via the AERIAL IN connector, first you have to set the programme position for each satellite channel using the TUNER menu. Then set the guide channel number for each satellite channel using the VIDEO Plus+ menu.

If your satellite tuner is connected via the LINE-1(TV) connector, you don't have to set programme positions nor guide channel numbers for satellite channels. Skip the following procedure.

- 1 Turn on the satellite tuner.
- 2 Press MENU, then select SETTINGS and press OK.
- 3 Select TUNER and press OK.
- 4 Press PROG +/- to select a programme position you want to use for watching a satellite channel.
- 5 Select CHANNEL SET, then press ? // repeatedly to tune the VCR to the satellite tuner.

The channel number displayed beside CHANNEL SET is used for receiving all satellite broadcasts from the satellite tuner.

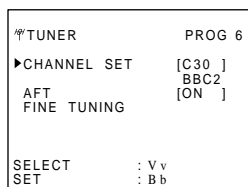

- 6 Press PROG +/- to select another programme position for the next satellite channel, and press the programme number buttons to enter the same channel number as the one displayed in step 5.  
Repeat this step for all satellite channels.
- 7 Set the guide channel number for each programme position assigned to the satellite channel, following the procedures on pages 17 and 18.

#### Notes

- The menu disappears automatically if you don't proceed for more than a few minutes.
- If you use a satellite tuner connected via the LINE-1 (TV) connector, you don't have to set up VIDEO Plus+. Just record a satellite programme using VIDEO Plus+, and the VCR automatically records the programme from the LINE-1 (TV) connector.
- If you inadvertently entered a guide channel number, press CLEAR.
- The VCR does not allow entering the guide channel number if the same number has been set.
- When you record a satellite broadcast using VIDEO Plus+, you need to select the desired channel on the satellite tuner manually.

# Setting your personal code

For identification, you can enter a personal code into the VCR. Once you enter your personal code, you can confirm it any time but can never change it. Make a note of the code to quote to the police if your VCR is stolen.

## Before you start...

- Turn on the TV.
- Set the TV to the video channel.
- If there is a tape in the VCR, remove it.
- Turn off the VCR.

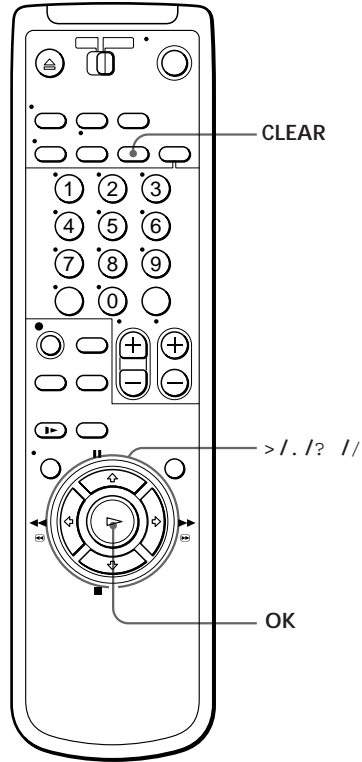
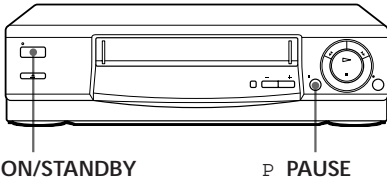

# 1

• ON/STANDBY



P PAUSE



Hold down **P PAUSE** and **ON/STANDBY** on the VCR simultaneously for more than three seconds.

SECURITY FUNCTION

PERSONAL CODE

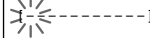

SELECT	: B b
SET	: V v
CONFIRM	: OK

continued

## Setting your personal code (continued)

2

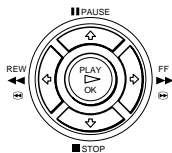

Enter your personal code.

1 Press > / . to select a character.

Each time you press > , the character changes as shown below.

A n B n ... n Z n 0 n 1 n ... n 9  
n (blank space) n - (hyphen) n A

2 Press / to set the next character.

The next space flashes.

To correct a character, press ? // until the character you want to correct flashes, then reset it.

You can set up to 11 characters for your personal code.

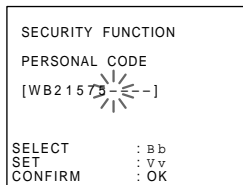

3

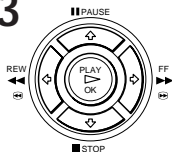

Press OK.

A confirmation screen appears.

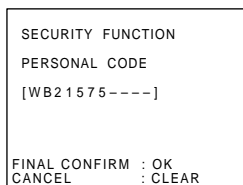

4

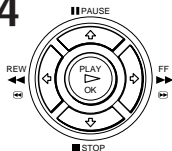

If the displayed personal code is correct, press OK.

If the displayed personal code is wrong, press CLEAR and continue from step 2.



### To confirm you personal ID

While the VCR is turned off and there is no tape in the VCR, hold down P PAUSE and ON/STANDBY on the VCR simultaneously for more than three seconds. The entered personal code appears on the TV screen. Press any button to enter normal viewing mode.

# Playing a tape

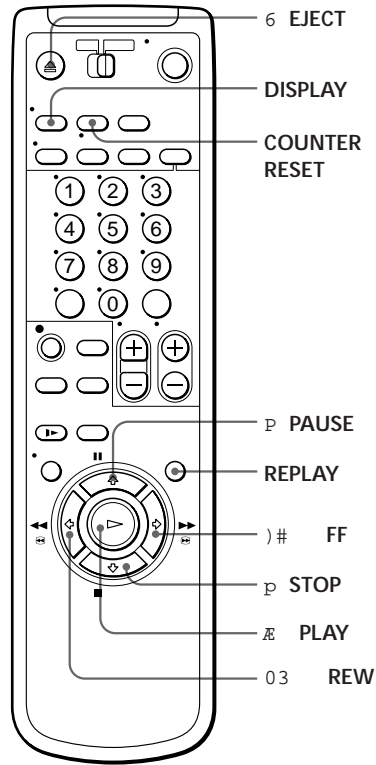

**1** Turn on your TV and set it to the video channel.

**2** Insert a tape.  
The VCR turns on and starts playing automatically if you insert a tape with its safety tab removed.

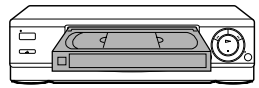

**3** Press **Æ PLAY**.  
When the tape reaches the end, it will rewind automatically.



continued

## Playing a tape (continued)

### Additional tasks

To	Press
Stop play	P STOP
Pause play	P PAUSE
Resume play after pause	P PAUSE or E PLAY
Fast-forward the tape	)# FF during stop
Rewind the tape	03 REW during stop
Eject the tape	6 EJECT

### To replay a recently watched scene

You can immediately rewind and playback the scene you want to watch again.

During playback, press REPLAY up to four times. The VCR rewinds the tape about 10 seconds on the counter for each press of the button, and restarts playback.

### To use the time counter

At the point on the tape that you want to find later, press COUNTER RESET. The counter in the display window resets to "0:00:00." Search for the point afterwards by referring to the counter.



To display the counter on the TV screen, press DISPLAY.

### Notes

- The counter resets to "0:00:00" whenever a tape is reinserted.
- The counter stops counting when it comes to a portion with no recording.
- While setting the menu on the TV screen, buttons for playback do not function.



# Recording TV programmes

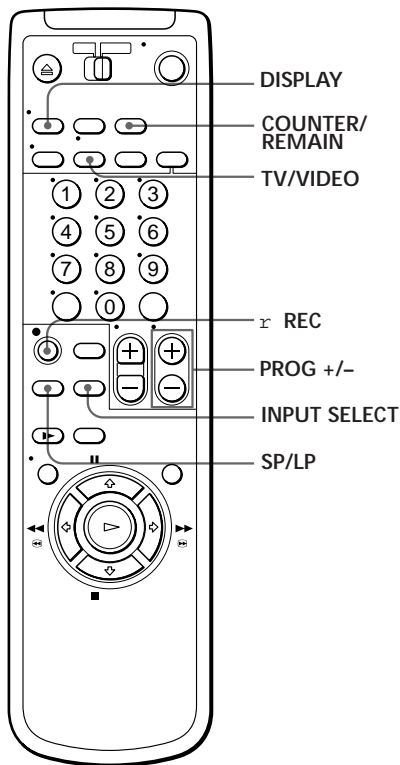

**1** Turn on your TV and set it to the video channel.  
To record from a decoder, turn it on.

**2** Insert a tape with its safety tab in place.

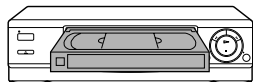

**3** Press INPUT SELECT until a programme position number appears in the display window.



continued

## Recording TV programmes (continued)

- 4 **•PROG** Press **PROG +/-** to select the programme position you want to record.

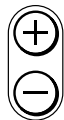

- 5 **SP/LP** Press **SP/LP** to select the tape speed, SP or LP.



LP (Long Play) provides recording time twice as long as SP (Standard Play), however, SP produces better picture and audio quality.



- 6 **•REC** Press **r REC** to start recording.



The recording indicator lights up red in the display window.



Recording indicator

To stop recording

Press **p STOP**.

## To check the remaining time

Press DISPLAY. With the display on, press COUNTER/REMAIN to check the remaining time. Each time you press COUNTER/REMAIN, the time counter and the remaining time appear alternately. The remaining time with the  indicator also appears in the display window.

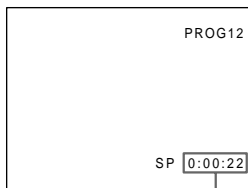

Time counter

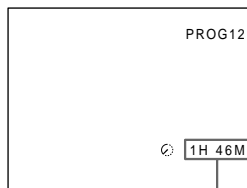

Remaining time

To correctly check the remaining time of the tape, set TAPE SELECT in the TAPE OPTIONS menu according to the tape type you use (see page 46).

## To watch another TV programme while recording

- 1 Press TV/VIDEO to turn off the VIDEO indicator in the display window.  
If the TV is connected to the VCR using only the aerial cable, skip this step.
- 2 Select another programme position on the TV.

## To save a recording

To prevent accidental erasure, break off the safety tab as illustrated. To record on a tape again, cover the tab hole with adhesive tape.



Safety tab

### Tips

- To select a programme position, you can use the programme number buttons on the remote commander. For two-digit numbers, press the ? (ten's digit) button followed by the programme number buttons.
- You can select a video source from the LINE-1 (TV) connector using INPUT SELECT or PROG +/- . When you use PROG +/- , "L" appears in the display window between the lowest programme position and the highest one.
- The display appears on the TV screen indicating information about the tape, but the information won't be recorded on the tape.
- If you don't want to watch TV while recording, you can turn off the TV.

### Notes

- The display does not appear during still (pause) mode or slow-motion playback.
- When you insert a non-standard commercially available tape, the remaining time may not be correct.
- The remaining time is intended for rough measurement only.
- If you play back the tape for about 30 seconds after you have inserted it, the remaining time will be displayed.

# Recording TV programmes using VIDEO Plus+

Just enter the programme's "PlusCode" listed in the TV programme guide. The date, times, and programme position of that programme are set automatically. You can preset up to eight programmes at a time.

## Before you start...

- Check that the VCR clock is set to the correct time.
- Insert a tape with its safety tab in place. Make sure the tape is longer than the total recording time.

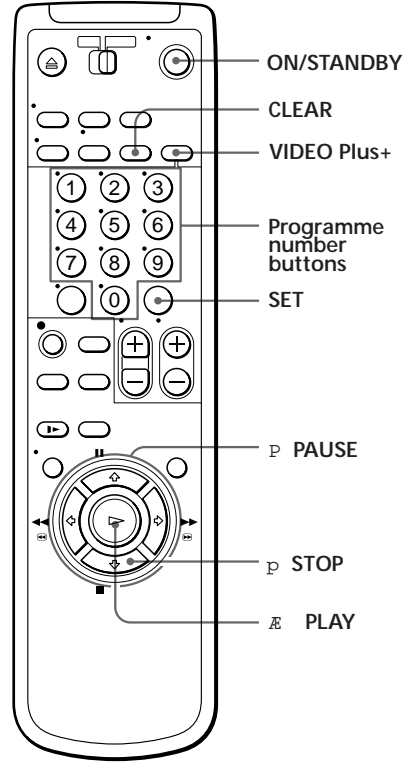

**1** VIDEO Plus+ Press VIDEO Plus+.

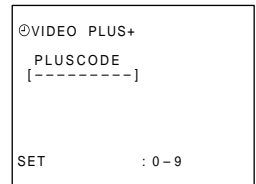

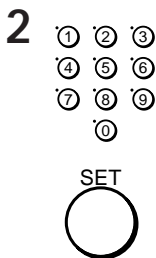

Press the programme number buttons to enter the programme's PlusCode, then press SET.

If you make a mistake, press VIDEO Plus+ before pressing SET and re-enter the correct number.

The date, start and stop times, programme position and tape speed appear on the TV screen.

If the information is incorrect, press CLEAR to cancel the setting.

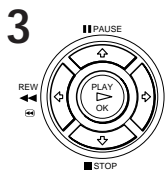
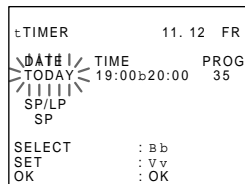

If you want to change the date, tape speed, and the VPS/PDC function setting:

- 1 Press ? // to flash the item you want to change.
- 2 Press > / . to reset it.

- To record the same programme every day or the same day every week, see "Daily/weekly recording" on page 30.
- To record from other source connected to the LINE-1 (TV) connector, press INPUT SELECT to display "L" in the "PROG" position.

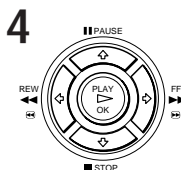
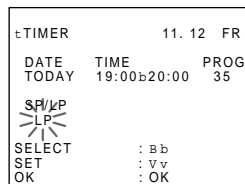

Press OK to complete the setting.



Press ON/STANDBY to turn off the VCR.

The indicator appears in the display window and the VCR stands by for recording.

To stop recording

To stop the VCR while recording, press STOP.

continued

---

## Recording TV programmes using VIDEO Plus+ (continued)

### Daily/weekly recording

In step 3 above, press **.** to select the recording pattern. Each time you press **.**, the indication changes as shown below. Press **>** to change the indication in reverse order.

TODAY **n** SU-SA (Sunday to Saturday) **n** MO-SA (Monday to Saturday) **n**  
MO-FR (Monday to Friday) **n** SA (every Saturday) .....  
**n** MO (every Monday) **n** SU (every Sunday) **n** 1 month later **n** (dates  
count down) **n** TODAY

### To record satellite broadcasts

If you connect the satellite tuner and the VCR, you can record satellite programmes.

- 1** Turn on the satellite tuner.
- 2** On the satellite tuner, select the satellite programme for which you want to make a timer setting.
- 3** Keep the satellite tuner turned on until the VCR finishes recording the satellite programme for which you have made a timer setting.

### To use the VCR after setting the timer

To use the VCR before a timer recording begins, just press ON/STANDBY. The **⏻** indicator turns off and the VCR switches on. Remember to press ON/STANDBY to reset the VCR after using the VCR.

You can also do the following tasks while the VCR is recording:

- Reset the counter.
- Display tape information on the TV screen.
- Check the timer settings.
- Watch another TV programme.

### Tips

- To set the tape speed, you can also use the SP/LP button.
- When you are recording a programme in the SP mode and the remaining tape becomes shorter than the recording time, the tape speed is automatically changed to the LP mode. Note that some interference will appear on the picture at the point the tape speed is changed. If you want to keep the same tape speed, set AUTO TAPE SPEED to OFF in the TAPE OPTIONS menu (page 39).

### Note

- If the PlusCode is incorrect, the VIDEO Plus+ menu appears instead of the TIMER menu after pressing SET.

# Setting the timer manually

If VIDEO Plus+ is not available in your area, follow the instructions below to set the timer to record programmes.

## Before you start...

- Check that the VCR clock is set to the correct time.
- Insert a tape with its safety tab in place. Make sure the tape is longer than the total recording time.
- Turn on your TV and set it to the video channel.
- To record from a decoder, turn it on.

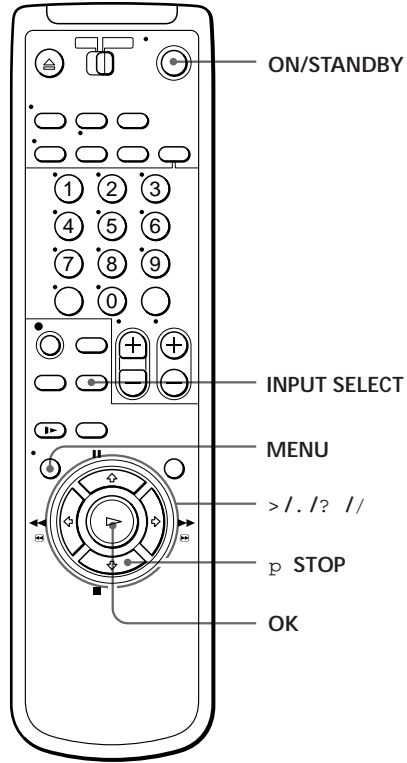

## 1 • MENU

Press MENU, then press >/. to select TIMER and press OK.

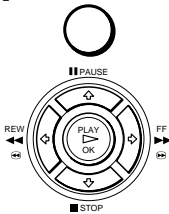

lTIMER	11. 12 FR	
DATE	TIME	PROG
TODAY	19:00b20:00	35
SP/LP		
SP		
SELECT	: b b	
SET	: v v	
OK	: OK	

continued

## Setting the timer manually (continued)

2

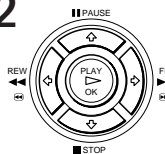

Set the date, start and stop times, programme position and tape speed:

1 Press ? // to flash each item in turn.

2 Press > / . to set each item.

To correct a setting, press ? to return to that setting and reset.

tTIMER	11. 12	FR
DATE	TIME	PROG
TODAY	19:00b20:00	35
SP/LP		
SELECT	:	B b
SET	:	V v
OK	:	OK

- To record the same programme every day or the same day every week, see “Daily/weekly recording” on page 33.
- To record from other source connected to the LINE-1 (TV) connector, press INPUT SELECT to display “L” in the “PROG” position.

3

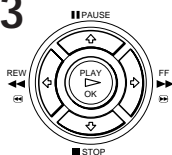

Press OK.

4



Press ON/STANDBY to turn off the VCR.

The  indicator appears in the display window and the VCR stands by for recording.

To record from a source, leave the connected equipment switched on.

### To stop recording

To stop the VCR while recording, press  STOP.



### To use the VCR after setting the timer

To use the VCR before a timer recording begins, just press ON/STANDBY. The  indicator turns off and the VCR switches on. Remember to press ON/STANDBY to reset the VCR after using the VCR.

You can also do the following tasks while the VCR is recording:

- Reset the counter.
- Display tape information on the TV screen.
- Check the timer settings.
- Watch another TV programme.

### Daily/weekly recording

In step 2 above, press **.** to select the recording pattern. Each time you press **.**, the indication changes as shown below. Press **>** to change the indication in reverse order.

TODAY **n** SU-SA (Sunday to Saturday) **n** MO-SA (Monday to Saturday) **n**  
 MO-FR (Monday to Friday) **n** SA (every Saturday) .....  
**n** MO (every Monday) **n** SU (every Sunday) **n** 1 month later **n** (dates  
 count down) **n** TODAY

### Tips

- To set the programme position, you can also use the PROG +/- or programme number buttons.
- To set the tape speed, you can also use the SP/LP button.
- When you are recording a programme in the SP mode and the remaining tape becomes shorter than the recording time, the tape speed is automatically changed to the LP mode. Note that some interference will appear on the picture at the point the tape speed is changed. If you want to keep the same tape speed, set AUTO TAPE SPEED to OFF in the TAPE OPTIONS menu (page 39).

### Note

- The  indicator flashes in the display window when you press ON/STANDBY with no tape inserted.

# Playing/searching at various speeds

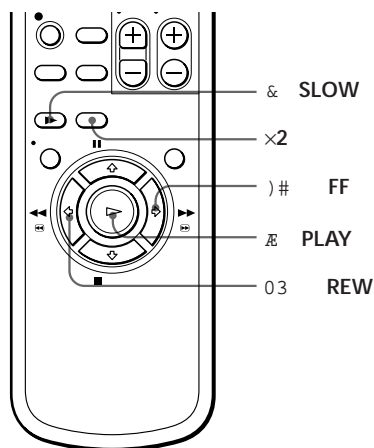
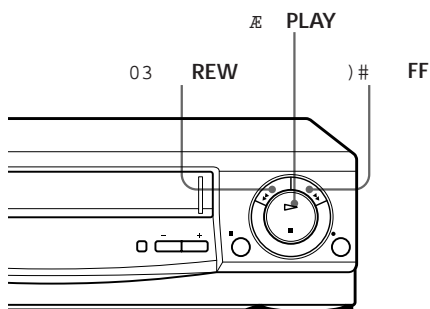

Playback options	Operation
View the picture during fast-forward or rewind	During fast-forward, hold down )# FF. During rewind, hold down 03 REW.
Play at high speed	<ul style="list-style-type: none"> <li>• During playback, press )# FF or 03 REW.</li> <li>• During playback, hold down )# FF or 03 REW. To resume normal playback, release the button.</li> </ul>
Play at twice the normal speed	During playback, press x2.
Play in slow motion	During playback or pause, press & SLOW.
Play frame by frame	During pause, press )# FF or 03 REW. Hold down the button to play one frame each second.
Rewind and start play	During stop, press PLAY on the VCR while holding down 03 REW on the VCR.

## To resume normal playback

Press PLAY.

### Tip

- Adjust the picture using the TRACKING +/- buttons on the VCR if:
    - streaks appear while playing in slow motion
    - the picture shakes while pausing.
- To set tracking to the centre position, press both buttons (+/-) at the same time.

### Notes

- The sound is muted during these operations.
- Tapes recorded in the LP mode on other VCRs can be played back on this VCR but the picture quality cannot be guaranteed.
- The picture may shake, be distorted or discoloured during the various playback operations.

# Recording TV programmes using the quick timer

After starting recording in the normal way, you can have the VCR stop recording automatically after a specified duration.

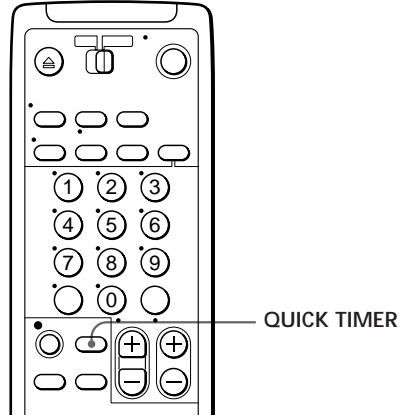

- 1 While recording, press QUICK TIMER once.  
The ⏸ indicator appears in the display window.



- 2 Press QUICK TIMER repeatedly to set the duration.  
Each press advances the time in increments of 30 minutes.

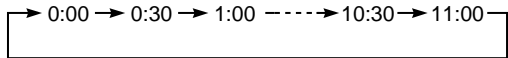

The duration decreases minute by minute to 0:00, then the VCR stops recording and turns off automatically.

## To extend the duration

Press QUICK TIMER repeatedly to set to the new duration.

## To stop recording

To stop the VCR while recording, press **p** STOP.

## Using the quick timer during stop mode

You can set the quick timer and start recording during stop mode by pressing QUICK TIMER. To set the channel, you can use the PROG +/- or INPUT SELECT buttons. Press QUICK TIMER repeatedly to set the recording duration. The recording will start automatically.

# Checking/ changing/ cancelling timer settings

Before you start...

- Turn on your TV and set it to the video channel.

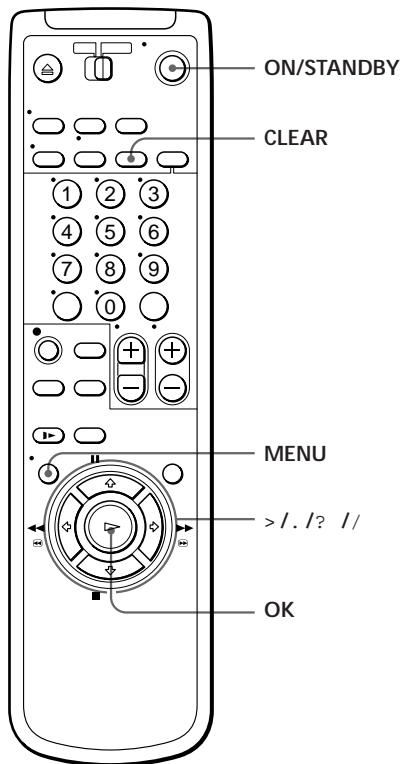

**1** Press ON/STANDBY to turn on the VCR.

**2** Press MENU, then press > / . to select LIST and press OK:

- If you want to change a setting, go on to the next step.
- If you do not need to change the settings, press OK, then turn off the VCR to return to recording standby.

tLIST		11. 12	FR
DATE	TIME	PROG	
▶TU	1900b2000	BBC2SP	
13. 12	0930b1000	CH5 SP	
11. 12	0500b0530	BBC1LP	
MO-FR	1200b1300	L LP	
MO-SA	2300b2330	L SP	
SU-SA	1212b1313	ITV LP	
--. -	----b ---	-- -	

**3** Press > / . to select the setting you want to change or cancel, then press OK.

- 4**
- To change the setting, press ? // to flash the item you want to change, and press > / . to reset it.
  - To cancel the setting, press CLEAR.

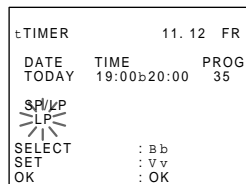

- 5** Press OK.

If any settings remain, turn off the VCR to return to recording standby.

### When the timer settings overlap

The programme that starts first has priority and the second programme starts recording only after the first programme has finished. If the programmes start at the same time, the programme listed first in the menu has priority.

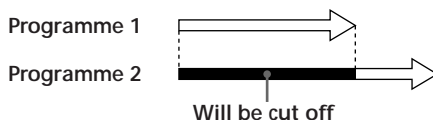

# Adjusting the picture

## Adjusting the tracking

Although the VCR automatically adjusts the tracking when playing a tape (the  indicator flashes in the display window, then goes off), distortion may occur if the tape was recorded in poor condition. If so, manually adjust the tracking.

During playback, press the TRACKING +/- buttons on the VCR to display the tracking meter. The distortion should disappear as you press one of the two buttons. (The  indicator lights up.) To resume automatic tracking adjustment eject the tape and restart it.

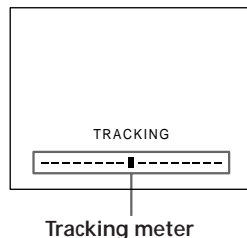

## About Optimum Picture Control (OPC)

Optimum Picture Control (OPC) automatically improves recording and playback quality by adjusting the VCR to the condition of the video heads and tape. To maintain better picture quality, we recommend that you set OPC to ON in the VIDEO OPTIONS menu (with the OPC indicator in the display window lit). For details, see page 39.

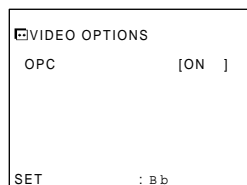

### OPC playback

The OPC function automatically works on all types of tapes, including rental tapes and tapes that were not recorded with OPC.

### OPC recording

Whenever you insert a tape and first start recording, the VCR adjusts to the tape using the OPC function (the OPC indicator flashes rapidly). This adjustment is retained until the tape is ejected.

### To deactivate the OPC

Press MENU and select SETTINGS, OPTIONS, VIDEO OPTIONS then set OPC to OFF. The OPC indicator in the display window goes off.

### Note

- There is a delay of a few seconds before the VCR actually starts recording while the VCR analyses the tape. To avoid the delay, first set the VCR to recording pause (the OPC indicator flashes slowly) and press **r** REC to have the VCR analyse the tape. After the OPC indicator stops flashing, press **P** PAUSE to start recording immediately. If you press **P** PAUSE before the OPC indicator stops flashing, the OPC function is cancelled.

# Changing menu options

- 1 Press MENU, then press > / . to select SETTINGS and press OK.

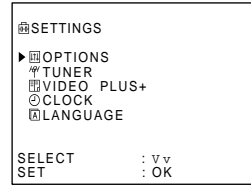

- 2 Press > / . to select OPTIONS, then press OK.

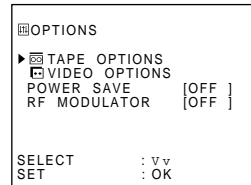

- 3 Press > / . to select the option you want to change:
  - To change the TAPE OPTIONS or VIDEO OPTIONS
    - 1 Press OK after selecting TAPE OPTIONS or VIDEO OPTIONS.
    - 2 Press > / . to select the option, then press ? // to change the setting.
  - To change the other options
 

Press ? // to change the setting.
- 4 Press OK to return to the original screen.

## Menu choices

Initial settings are indicated in bold print.

### TAPE OPTIONS

Menu option	Set this option to
AUTO TAPE SPEED	<ul style="list-style-type: none"> <li>• ON to change the timer recording tape speed automatically to the LP mode when the remaining tape becomes shorter than the recording time.</li> <li>• OFF to keep the set tape speed.</li> </ul>
TAPE SELECT	<ul style="list-style-type: none"> <li>• 300 to use an E-300 type tape.</li> <li>• 240 to use an E-240 type tape.</li> <li>• 195 to use an E-195 or shorter type tape.</li> </ul>

continued

---

## Changing menu options (continued)

### VIDEO OPTIONS

---

Menu option	Set this option to
OPC	<ul style="list-style-type: none"><li>• <b>ON</b> to switch on the OPC (Optimum Picture Control) function and improve picture quality.</li><li>• <b>OFF</b> to switch off OPC.</li></ul>

---

### Other options

---

Menu option	Set this option to
POWER SAVE	<ul style="list-style-type: none"><li>• <b>OFF</b> to turn on the indicators in the display window while the VCR is standing by.</li><li>• <b>ON</b> to turn off the indicators in the display window to conserve the VCR power.</li></ul>
RF MODULATOR	<ul style="list-style-type: none"><li>• <b>ON</b> if you connect the VCR to your TV using only the aerial cable.</li><li>• <b>OFF</b> if you connect the VCR to your TV using the EURO-AV cable.</li></ul>

---

### Note

- When you set a timer recording, the indicators in the display window are on even though POWER SAVE is set to ON.



# Editing with another VCR

## Connecting to record on this VCR

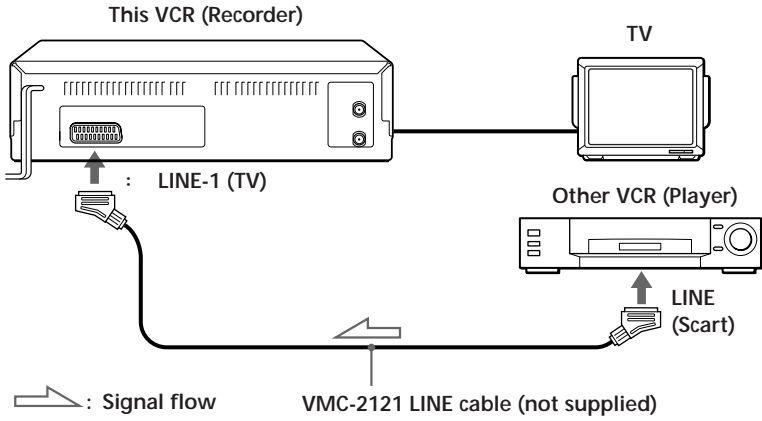

continued

## Editing with another VCR (continued)

### Operation (when recording on this VCR)

#### Before you start editing

- Turn on your TV and set it to the video channel.
- Press INPUT SELECT to display “L” in the display window.
- Press SP/LP to select the tape speed, SP or LP.

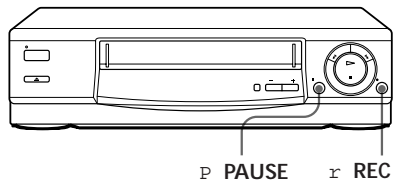

- 1** Insert a source tape with its safety tab removed into the other (playback) VCR. Search for the point to start playback and set it to playback pause.
- 2** Insert a tape with its safety tab in place into this (recording) VCR. Search for the point to start recording and press **P PAUSE**.
- 3** Press **r REC** on this VCR and set it to recording pause.
- 4** To start editing, press the **P PAUSE** buttons on both VCRs at the same time.

#### To stop editing

Press the **P STOP** buttons on both VCRs.

#### Tips

- To edit more precisely, press the **P PAUSE** buttons on the VCRs to release pause.
- To cut out unwanted scenes while editing, press **P PAUSE** on this VCR when an unwanted scene begins. When it ends, press **P PAUSE** again to resume recording (Assemble Editing).

#### Note

- If you start recording following the procedure above, the VCR won't start recording with the OPC function. To record a tape with the OPC function, press **r REC** again during recording pause in step 3 so that the VCR analyses the tape. Then, when you start editing in step 4, press **P PAUSE** after the OPC indicator stops flashing. If you press **P PAUSE** before the OPC indicator stops flashing, the OPC function is cancelled.

# Troubleshooting

If you have any questions or problems not covered below, please consult your nearest Sony service facility.

	Symptom	Remedy
Power	The ON/STANDBY switch does not function.	<ul style="list-style-type: none"> <li>• Connect the mains lead to mains securely.</li> </ul>
	The power is turned on but the VCR does not operate.	<ul style="list-style-type: none"> <li>• Moisture condensation occurs. Turn the power off, unplug the mains lead and leave the VCR to dry for over one hour.</li> </ul>
Clock	The clock has stopped and “-:-” lights in the display window.	<ul style="list-style-type: none"> <li>• The clock stops if the VCR is disconnected from the mains for more than an hour. Reset the clock (and timer).</li> </ul>
Playback	The playback picture does not appear on the TV screen.	<ul style="list-style-type: none"> <li>• Make sure the TV is set to the video channel. If you are using a monitor, set it to video input.</li> <li>• If the VCR is connected to the TV only with the aerial cable, make sure that RF MODULATOR in the OPTIONS menu is set to ON.</li> </ul>
	The picture is not clear.	<ul style="list-style-type: none"> <li>• Adjust the tracking with the TRACKING +/- buttons.</li> <li>• The video heads are dirty (see below). Clean the video heads using the Sony T-25CLD, E-25CLDR, or T-25CLW video head cleaning cassette. If these cleaning cassettes are not available in your area, have the heads cleaned at your nearest Sony service facility (a standard service charge will be required). Do not use a commercially available liquid-type cleaning cassette other than Sony’s, as it may damage the video heads.</li> <li>• The video heads may have to be replaced. Consult your local Sony service facility for more information.</li> </ul>
	The picture rolls vertically during picture search.	<ul style="list-style-type: none"> <li>• Adjust the vertical hold control on the TV or monitor.</li> </ul>
	The picture has no sound.	<ul style="list-style-type: none"> <li>• The tape is defective. Use a new tape.</li> </ul>

## Symptoms caused by contaminated video heads

- Normal picture
- Rough picture
- Unclear picture
- No picture (or black & white screen appears)



initial contamination

terminal

continued

## Troubleshooting (continued)

	Symptom	Remedy
Recording	No TV programme appears on the TV screen.	<ul style="list-style-type: none"> <li>• Make sure the TV is set to the video channel. If you are using a monitor, set it to video input.</li> <li>• If the VCR is connected to the TV using only the aerial cable, make sure that RF MODULATOR in the OPTIONS menu is set to ON.</li> </ul>
	TV reception is poor.	<ul style="list-style-type: none"> <li>• Adjust the TV aerial.</li> </ul>
	The tape starts playing as soon as it is inserted.	<ul style="list-style-type: none"> <li>• The safety tab has been removed. To record on this tape, cover the tab hole.</li> </ul>
	The tape is ejected when you press $\pi$ REC.	<ul style="list-style-type: none"> <li>• Check that the safety tab has not been removed.</li> </ul>
Timer recording	Nothing happens when you press $\pi$ REC.	<ul style="list-style-type: none"> <li>• Make sure the tape is not at its end.</li> <li>• Select the correct source with the INPUT SELECT button. Select a programme position when recording TV programmes; select "L" when recording from other equipment.</li> </ul>
	The timer does not operate.	<ul style="list-style-type: none"> <li>• Check that the clock is set.</li> <li>• Make sure a tape has been inserted.</li> <li>• Check that the safety tab has not been removed.</li> <li>• Make sure the tape is not at its end.</li> <li>• Make sure a programme has been set for timer recording.</li> <li>• Make sure your timer settings have not already passed the current time.</li> <li>• Check that the decoder is turned on.</li> <li>• Check that the satellite tuner is turned on.</li> <li>• The clock stops if the VCR is disconnected from the mains for more than one hour. Reset the clock and timer.</li> </ul>

	Symptom	Remedy
Others	A tape cannot be inserted.	<ul style="list-style-type: none"> <li>• Check that a tape isn't already in the tape compartment.</li> </ul>
	The remote commander does not function.	<ul style="list-style-type: none"> <li>• Make sure you are pointing the remote commander at the remote sensor on the VCR.</li> <li>• Replace all the batteries in the remote commander with new ones if they are weak.</li> <li>• Make sure the [TV] [VIDEO] remote control switch is set correctly.</li> </ul>
	The tracking meter does not appear on the screen.	<ul style="list-style-type: none"> <li>• The recording condition of the tape is very poor and tracking cannot be adjusted or the NTSC system is being used.</li> </ul>
	The VCR needs to be cleaned.	<ul style="list-style-type: none"> <li>• Clean the cabinet, panel and controls with a dry, soft cloth, or a soft cloth slightly moistened with a mild detergent solution. Do not use any type of solvent, such as alcohol or benzine.</li> </ul>

---

# Specifications

## System

Channel coverage

SLV-E230UY:

PAL (I)

UHF B21 - B69

SLV-E230EY:

PAL (I)

VHF A - J

UHF B21 - B69

CATV S01 - S05, S1 - S20

HYPER S21 - S41

RF output signal

UHF channels 21 to 69

Aerial out

75-ohm asymmetrical aerial socket

## Inputs and outputs

: LINE-1 (TV)

21-pin

Video input: pin 20

Audio input: pins 2 and 6

Video output: pin 19

Audio output: pins 1 and 3

## General

Power requirements

220 - 240 V AC, 50 Hz

Power consumption

20 W

Operating temperature

5°C to 40°C

Storage temperature

-20°C to 60°C

Dimensions

Approx. 355 × 96 × 285 mm (w/h/d)

including projecting parts and controls

Mass

Approx. 3.9 kg

## Supplied accessories

Remote commander (1)

R6 (size AA) batteries (2)

Aerial cable (1)

Design and specifications are subject to change without notice.

---

# Index to parts and controls

Refer to the pages indicated in parentheses ( ) for details.

## Front panel

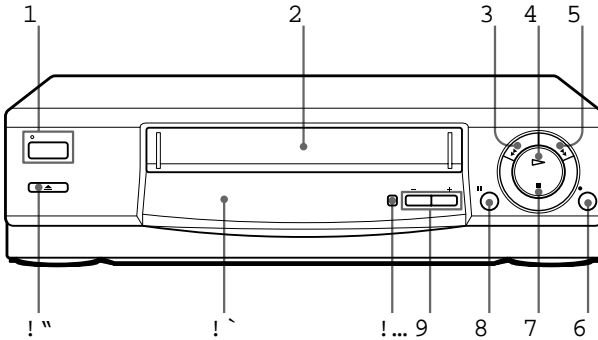

- |   |                                      |       |   |
|---|--------------------------------------|-------|---|
| 1 | ON/STANDBY switch/indicator (29)     | 8     | P PAUSE button (24)                                     |
| 2 | Tape compartment                     | 9     | PROGRAM/TRACKING +/- buttons (26, 38)                   |
| 3 | 03 REW (rewind) button (24, 34)      | ! ... | AUTO SET UP/RF (Radio Frequency) CHANNEL button (8, 10) |
| 4 | Æ PLAY button (23)                   | ! ^   | Remote sensor (5)                                       |
| 5 | )# FF (fast-forward) button (24, 34) | ! "   | 6 EJECT button (24)                                     |
| 6 | r REC (record) button (26)           |       |   |
| 7 | p STOP button (26)                   |       |   |

continued

## Display window

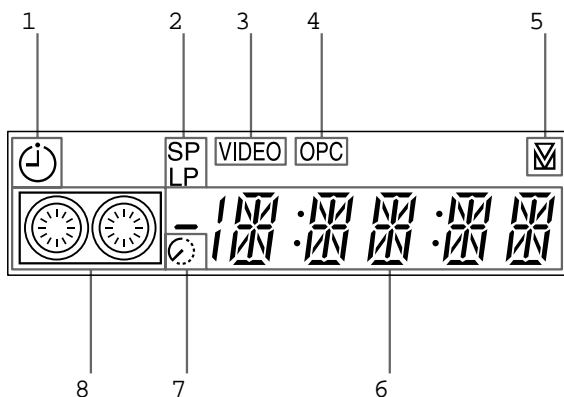

- |   |   |   |  |
|---|---|---|--|
| 1 | Timer indicator (29)                            | 6 | Time counter/clock/line/<br>programme position indicator<br>(24, 26, 42) |
| 2 | Tape speed indicators (26)                      | 7 | Remaining time indicator (27)  |
| 3 | VIDEO indicator (27)                            | 8 | Tape/recording indicator (26)  |
| 4 | OPC (Optimum Picture Control)<br>indicator (38) |   |  |
| 5 | Tracking indicator (38)                         |   |  |



## Rear panel

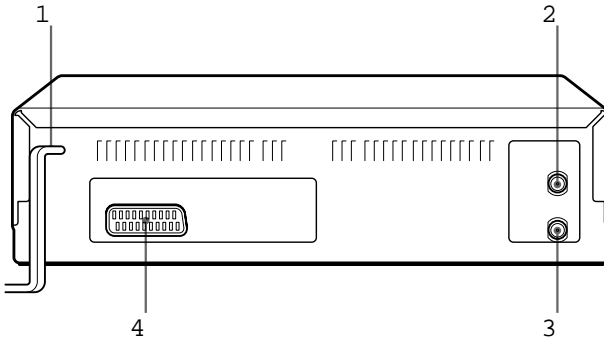

- |   |   |   |   |
|---|---|---|---|
| 1 | Mains lead (7)                            | 3 | AERIAL OUT<br>ANTENNE SORTIE connector (7)        |
| 2 | AERIAL IN<br>ANTENNE ENTREE connector (7) | 4 | : LINE-1 (TV)<br>: LIGNE-1 (TV) connector (7, 41) |

continued

## Index to parts and controls (continued)

### Remote commander

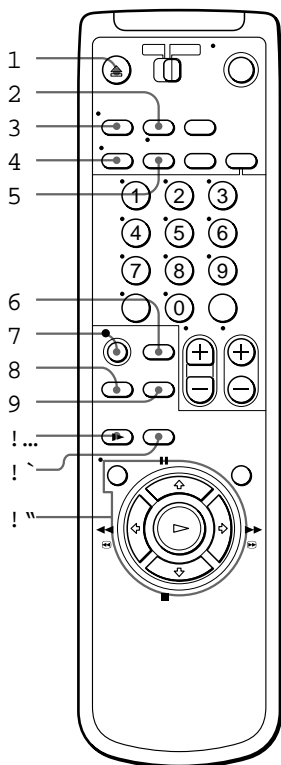

- 1 6 EJECT button (24)
- 2 COUNTER RESET button (24)
- 3 DISPLAY button (24)
- 4 WIDE button (*for TV*) (6)
- 5 TV/VIDEO button (27)
- 6 QUICK TIMER button (35)
- 7  $\square$  REC (record) button (26)
- 8 SP (Standard Play)/LP (Long Play) button (26)
- 9 INPUT SELECT button (25, 29)
- !... & SLOW button (34)
- ! `  $\times 2$  button (34)
- ! " Tape/menu operatin buttons
  - MENU button (11, 39)
  - $\square$  PAUSE/ $\triangleright$  button (24)
  - $\square$  STOP/. button (26)
  - 0 3 REW (rewind)/? button (24, 34)
  - ) # FF (fast-forward)// button (24, 34)
  - $\square$  PLAY/OK button (23)

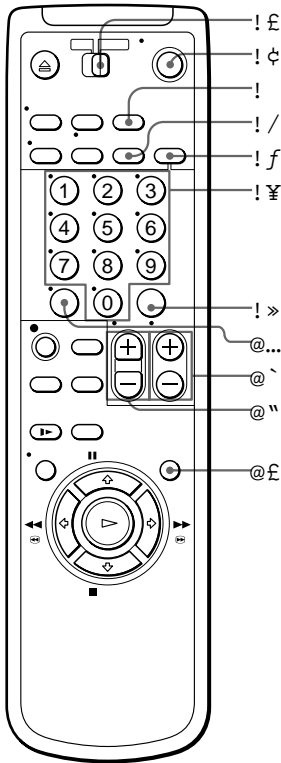

- ! £ [TV] [VIDEO] remote control switch (5)
- ! ¢ ON/STANDBY switch (29)
- ! COUNTER/REMAIN button (27)
- ! / CLEAR button (37)
- ! f VIDEO Plus+ button (28)
- ! ¥ Programme number buttons (18, 29)
- ! » SET button (29)
- @... ? (ten's digit) button (27)
- @ ` PROG (programme) +/- buttons (26)
- @ " VOL (volume) +/- buttons (for TV) (6)
- @ £ REPLAY button (24)

---

# Index

## A, B

- Aerial hookup 7
- AFT (Auto Fine Tuning) 16

## C

- Cancelling timer settings 36
- Changing timer settings 36
- Checking timer settings 36
- Cleaning the video heads 43
- Clock setting 11
- Connecting the VCR and your TV 7
- Colour system
  - compatible colour systems 2
- Counter 24

## D

- Disabling programme position 16
- Dubbing. *See* Editing

## E, F, G, H, I, J, K

- Editing 41

## L, M, N

- LP mode 26

## O

- OPC (Optimum Picture Control) 38

## P

- Picture adjustment 38
- Playback 23
  - at various speeds 34
  - frame-by-frame 34
  - slow motion 34
- Presetting channels 14

## Q

- Quick timer 35

## R

- Recording 25
  - saving 27
  - while watching another programme 27
- Remote commander 5
- RF channel 9

## S

- Safety tab 27
- Searching at various speeds 34
- SP mode 26

## T, U

- Timer recording 31
  - cancelling timer settings 36
  - changing timer settings 36
  - checking timer settings 36
  - daily/weekly recording 30
  - overlapping timer recordings 37
- Tracking adjustment 38

## V, W, X, Y, Z

- VIDEO Plus+ 17
  - recording 28