Index

A, B

- Aerial hookup 7
- AFT (Auto Fine Tuning) 20

C

- Cancelling timer settings 41
- Changing timer settings 41
- Checking timer settings 41
- Cleaning the video heads 48
- Clock setting 12
- Connecting
 - the VCR and your TV 7
 - to a TV with a LINE (TV) connector 7
- Colour system
 - compatible colour systems 2
- Counter 25

D

- Disabling programme position 20
- Dubbing. *See* Editing

E, F, G, H, I, J, K

- Editing 46

L, M

- LINE (TV) connection 7
- LP mode 26, 28

N

- NTSC recorded tape 25

O

- OPC (Optimum Picture Control) 43

P

- Picture adjustment 43
- Playback 24
 - at various speeds 38
 - frame-by-frame 38
 - slow motion 38
- Presetting channels 18

Q

- Quick timer 40

R

- Recording 27
 - saving 29
 - while watching another programme 29
- Remote commander 5
- RF channel 8

S

- Safety tab 29
- Searching at various speeds 38
- SP mode 28

T, U, V, W, X, Y, Z

- Timer recording 35
 - cancelling timer settings 41
 - changing timer settings 41
 - checking timer settings 41
 - daily/weekly recording 33, 37
 - overlapping timer recordings 42
- Tracking adjustment 43

Video Cassette Recorder

Operating Instructions



SLV-E480EG **SHOWVIEW**
SLV-E477EG
SLV-E380EG **SHOWVIEW**

WARNING

To prevent fire or shock hazard, do not expose the unit to rain or moisture.

To avoid electrical shock, do not open the cabinet. Refer servicing to qualified personnel only.

The mains lead must be changed only at a qualified service shop.

Precautions

Safety

- This unit operates on 220 – 240 V AC, 50 Hz. Check that the unit's operating voltage is identical with your local power supply.
- If anything falls into the cabinet, unplug the unit and have it checked by qualified personnel before operating it any further.
- The unit is not disconnected from the mains as long as it is connected to the mains, even if the unit itself has been turned off.
- Unplug the unit from the mains if you do not intend to use it for an extended period of time. To disconnect the lead, pull it out by the plug, never by the lead.

Installing

- Allow adequate air circulation to prevent internal heat buildup.
- Do not place the unit on surfaces (rugs, blankets, etc.) or near materials (curtains, draperies) that may block the ventilation slots.
- Do not install the unit near heat sources such as radiators or air ducts, or in a place subject to direct sunlight, excessive dust, mechanical vibration or shock.
- Do not install the unit in an inclined position. It is designed to be operated in a horizontal position only.
- Keep the unit and cassettes away from equipment with strong magnets, such as microwave ovens or large loudspeakers.
- Do not place heavy objects on the unit.
- If the unit is brought directly from a cold to a warm location, moisture may condense inside the VCR and cause damage to the video head and tape. When you first install the unit, or when you move it from a cold to a warm location, wait for about one hour before operating the unit.

Caution

Television programmes, films, video tapes and other materials may be copyrighted.

Unauthorized recording of such material may be contrary to the provisions of the copyright laws. Also, use of this recorder with cable television transmission may require authorization from the cable television transmitter and/or programme owner.

Compatible colour systems

- This VCR is designed to record and play back using the PAL and MESECAM colour systems (TV systems B/G and D/K) and play back using the NTSC 4.43 colour system. Recording of video sources based on other colour systems cannot be guaranteed.
- Tapes recorded with the NTSC colour system can be played back on this unit using a TV or a colour monitor for the PAL colour system.

Table of contents

Getting Started

- 4 Step 1: Unpacking
- 5 Step 2: Setting up the remote commander
- 7 Step 3: Connecting the VCR
- 8 Step 4: Tuning your TV to the VCR
- 10 Step 5: Setting up the VCR with the Auto Set Up function
- 12 Step 6: Setting the clock
- 17 Manual setup —
 - Selecting a language, Presetting channels, Setting up ShowView*

Basic Operations

- 24 Playing a tape
- 27 Recording TV programmes
- 31 Recording TV programmes using ShowView
- 35 Setting the timer manually

Additional Information

- 48 Troubleshooting
- 51 Specifications
- 52 Index to parts and controls
- Back cover
- Index

Additional Operations

- 38 Playing/searching at various speeds
- 40 Recording TV programmes using the quick timer
- 41 Checking/changing/cancelling timer settings
- 43 Adjusting the picture
- 44 Changing menu options
- 46 Editing with another VCR

* ShowView is a trademark applied for by Gemstar Development Corp. ShowView system is manufactured under license from Gemstar Development Corporation.

Step 1

Unpacking

Check that you have received the following items with the VCR:

- Remote commander

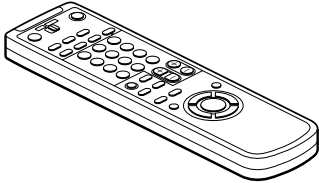

- Aerial cable

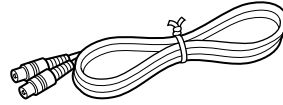

- R6 (size AA) batteries

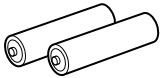

Checking your model name

The instructions in this manual are for the 3 models : SLV-E480EG, E477EG, and E380EG. Check your model number by looking at the rear panel of your VCR. The SLV-E480EG is the model used for illustration purposes. Any difference in operation is clearly indicated in the text, for example, "SLV-E477EG only."

Step 2

Setting up the remote commander

Inserting the batteries

Insert two R6 (size AA) batteries by matching the + and - on the batteries to the diagram inside the battery compartment.

Insert the negative (-) end first, then push in and down until the positive (+) end clicks into the position.

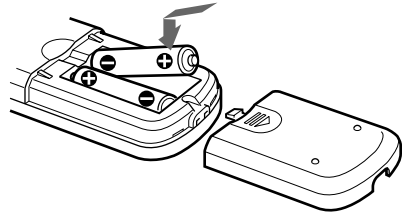

Using the remote commander

You can use this remote commander to operate this VCR and a Sony TV. Buttons on the remote commander marked with a dot (•) can be used to operate your Sony TV.

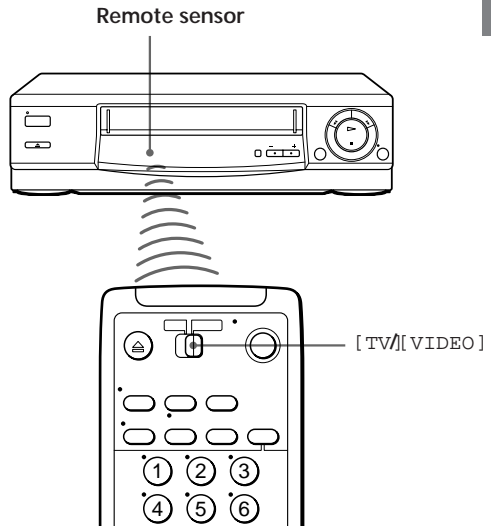

To operate	Set [TV] / [VIDEO] to
the VCR	[VIDEO] and point at the remote sensor on the VCR
a Sony TV	[TV] and point at the remote sensor on the TV

continued

Step 2 : Setting up the remote commander (continued)

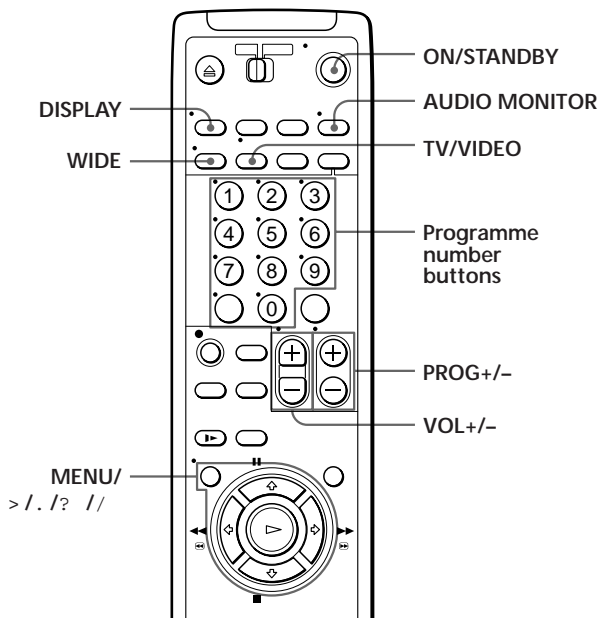

TV control buttons

To	Press
Turn the TV into standby or active mode	ON/STANDBY
Select an input source of the TV either from aerial in or from line in	TV/VIDEO
Select the programme position of the TV	Programme number buttons PROG +/-
Adjust the volume of the TV	VOL +/-
Select the sound type (stereo/mono) of your stereo Sony TV (SLV-E477EG only)	AUDIO MONITOR
Call up on-screen display	DISPLAY
Operate TV menu options	MENU/> / . / ? / //
Switch the wide mode	WIDE

Notes

- With normal use, the batteries should last about three to six months.
- If you do not use the remote commander for an extended period of time, remove the batteries to avoid possible damage from battery leakage.
- Do not use a new battery with an old one.
- Do not use different types of batteries.
- Some buttons may not work with certain Sony TVs.

Step 3

Connecting the VCR

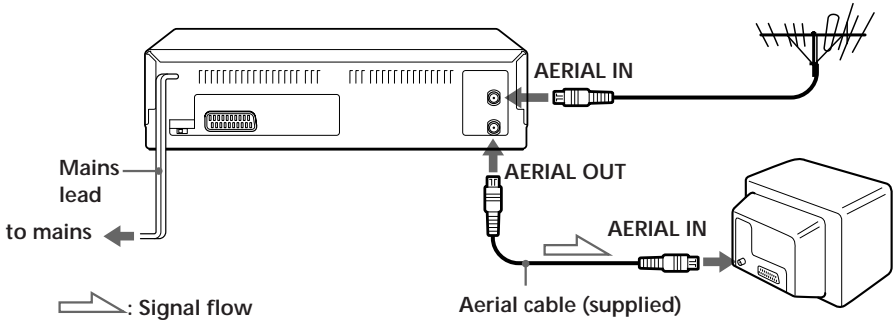

1

Disconnect the aerial cable from your TV and connect it to AERIAL IN on the rear panel of the VCR.

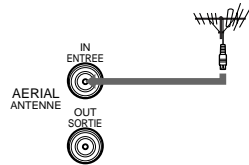

2

Connect AERIAL OUT of the VCR and the aerial input of your TV using the supplied aerial cable.

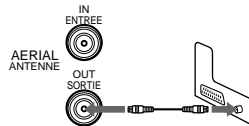

3

Connect the mains lead to the mains.

Additional connection

To a TV that has a EURO-AV (Scart) connector

This additional connection improves picture and sound quality. Connect the TV as shown on the right. Whenever you want to watch the VCR picture, press TV/VIDEO to display the VIDEO indicator in the display window.

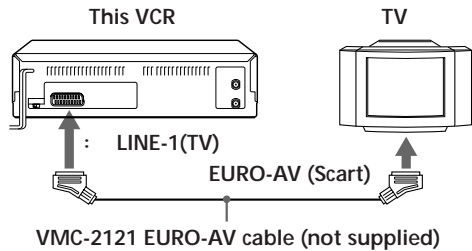

Step 4

Tuning your TV to the VCR

If you connect the VCR to your TV using the EURO-AV cable, skip this step.

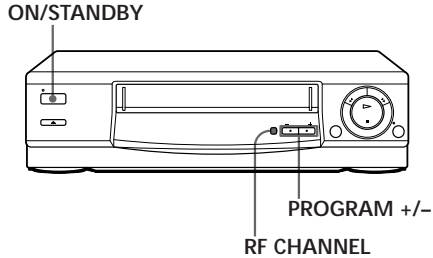

- 1**  Press ON/STANDBY to turn on the VCR.

- 2**  Press RF CHANNEL on the VCR.
The factory-preset RF channel appears in the display window.
The VCR signal is output through this channel to the TV.

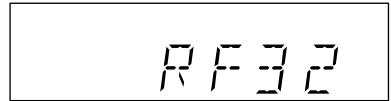

- 3** Turn on your TV and select a programme position for the VCR picture.
This programme position will now be referred to as the video channel.

- 4**  Press RF CHANNEL.
The TV system appears in the display window.

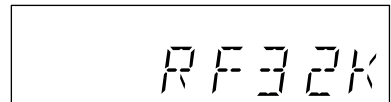

5

•PROG

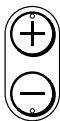

Press PROGRAM +/- (repeatedly) to select the correct TV system. If you watch the system B/G, select "G". If you watch the system D/K, select "K".

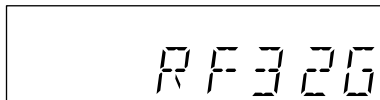

6

Tune the TV to the same channel as that shown in the display window so that the picture on the right appears on the TV screen.

Refer to your TV manual for tuning instructions.

If the picture does not appear clearly, see "To obtain a clear picture from the VCR" below.

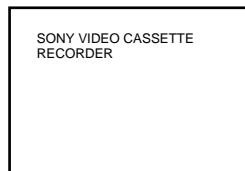

7

AUTO SET UP



RF CHANNEL

Press RF CHANNEL.

You have now tuned your TV to the VCR. Whenever you want to play a tape, set the TV to the video channel.

To check to see if the TV tuning is correct

Set the TV to the video channel and press PROGRAM +/- on the VCR. If the TV screen changes to a different programme each time you press PROGRAM +/-, the TV tuning is correct.

To obtain a clear picture from the VCR

If the picture does not appear clearly in step 6 above, go to step 7 to finish this procedure once. Then start from step 2. After pressing RF CHANNEL in step 2 to display the RF channel, press PROGRAM +/- so that another RF channel appears. Then tune the TV to the new RF channel until a clear picture appears.

Note

- If you set the wrong TV system, you may have no sound or sound may be distorted.

Step 5

Setting up the VCR with the Auto Set Up function

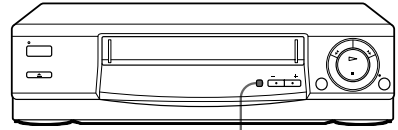

AUTO SET UP

Before using the VCR for the first time, set up the VCR using the Auto Set Up function. With this function, you can set the language for the on-screen display and TV channels, guided by the sequence indicated in the display window.

1

AUTO SET UP



RF CHANNEL

Hold down AUTO SET UP on the VCR for more than three seconds.

The VCR automatically turns on, and the country abbreviation for the ATP (Auto Tuner Preset) function appears in the display window.

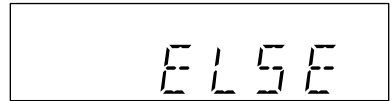

2

- PROGRAM +

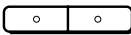

TRACKING

Press PROGRAM +/- on the VCR to select the abbreviation of your country.

The abbreviations of the countries are as follows:

Abbreviation	Contry
CZ	Czech
H	Hungary
PL	Poland
RU	Russia
ELSE	Other countries

If your country does not appear, select ELSE.

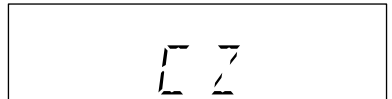

3

AUTO SET UP



RF CHANNEL

Press AUTO SET UP.

The ATP function starts searching for all of the receivable channels and presets them in numerical order.

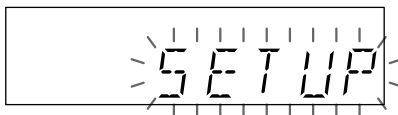

When no more receivable channels can be found, presetting stops and “SET UP” disappears from the display window.

(SLV-E380EG only)

The current time appears in the display window for any stations that transmit a time signal.

To cancel the Auto Set Up function

Press AUTO SET UP.

Tip

- If you want to change the language for the on-screen display from the one preset in the Auto Set Up function, see page 17.

Note

- Do not cancel the Auto Set Up function during the ATP operations. If you do, repeat the steps above.

Step 6

Setting the clock

You must set the time and date on the VCR to use the timer recording features properly.

SLV-E380EG only:

The Auto Clock Set function works only if a station in your area is broadcasting a time signal. If the Auto Set Up function did not set the clock correctly for your local area, try another station for the Auto Clock Set function.

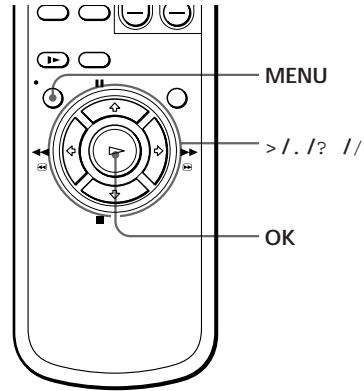

Before you start...

- Turn on the VCR and the TV.
- Set the TV to the video channel.

Setting the clock manually

1 • MENU

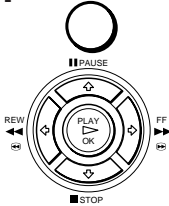

Press MENU, then press >/. to select SETTINGS and press OK.

```

SETTINGS
▶ OPTIONS
TUNER
SHOWVIEW
CLOCK
LANGUAGE

```

```

SELECT : V v
SET : OK

```

2

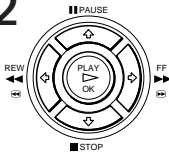

Press >/. to select CLOCK and press OK.

e.g. SLV-E380EG

```

tCLOCK
1. 1. 1998 TH 0:00
▶ AUTO ADJUST [OFF]

```

```

SELECT : V v
SET : B b
END : OK

```

3

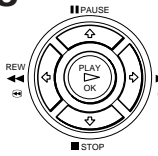

(SLV-E380EG only):

Press > / . to move the cursor () to the clock row, then press / .

The day starts flashing.

e.g. SLV-E380EG

tCLOCK	
	1. 1998 TH 0 : 00
AUTO ADJUST	[OFF]
SELECT	: B b
SET	: V v
END	: OK

4

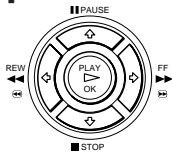

Press > / . to set the date.

e.g. SLV-E380EG

tCLOCK	
	1. 1998 SU 0 : 00
AUTO ADJUST	[OFF]
SELECT	: B b
SET	: V v
END	: OK

5

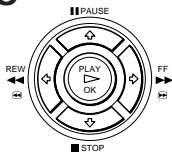

Press / to flash the month and set the month using > / . .

e.g. SLV-E380EG

tCLOCK	
11	 1. 1998 SU 0 : 00
AUTO ADJUST	[OFF]
SELECT	: B b
SET	: V v
END	: OK

6

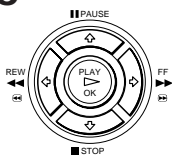

Set the year, hour, and minutes in sequence, using / to flash the item to be set, and press > / . to select the digits.

The day of the week is set automatically.

e.g. SLV-E380EG

tCLOCK	
11. 12.	 1998 FR 15 : 30
AUTO ADJUST	[OFF]
SELECT	: B b
SET	: V v
END	: OK

7

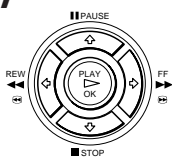

Press / to start the clock.

e.g. SLV-E380EG

tCLOCK	
	11. 12. 1998 FR 15 : 30
AUTO ADJUST	[OFF]
SELECT	: V v
SET	: B b
END	: OK

continued

Step 6: Setting the clock (continued)

8

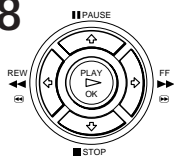

Press OK.

Tip

- To change the digits during setting, press ? to return to the item to be changed, and select the digits using > / . .

Note

- The menu disappears automatically if you don't proceed for more than a few minutes.

Changing the station for the Auto Clock Set function (SLV-E380EG only)

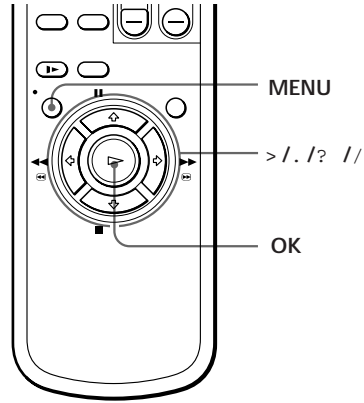

- 1** •MENU Press MENU, then press > / . to select SETTINGS and press OK.

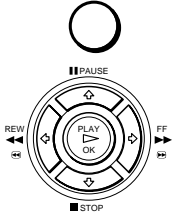

```

SETTINGS
▶ OPTIONS
  TUNER
  SHOWVIEW
  CLOCK
  LANGUAGE
  
```

```

SELECT : V v
SET     : OK
  
```

- 2** Press > / . to select CLOCK and press OK. The cursor () is on AUTO ADJUST.

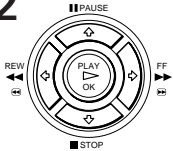

⌚CLOCK

1. 1. 1998 TH 0 : 00

▶AUTO ADJUST [OFF]

```

SELECT : V v
SET     : B b
END     : OK
  
```

- 3** Press / to select ON.

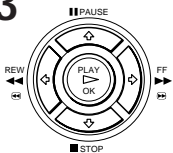

⌚CLOCK

11. 12. 1998 FR 15 : 30

▶AUTO ADJUST [ON]
CLOCK PROG [1]

```

SELECT : V v
SET     : B b
END     : OK
  
```

continued

Step 6: Setting the clock (continued)

4

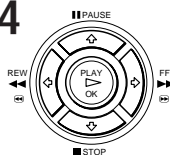

Press **.** to move the cursor () to **CLOCK PROG**, then press **? //** repeatedly until the programme position of the station that carries the time signal appears.

If the VCR does not receive the time signal from any station, **AUTO ADJUST** returns to **OFF** automatically.

tCLOCK	
1. 1. 1998 TH	0 : 00
AUTO ADJUST	[ON]
▶CLOCK PROG	[4]
SELECT	: V V
SET	: B B
END	: OK

5

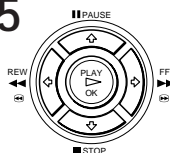

Press **OK**.

Tip

- If you set **AUTO ADJUST** to **ON**, the Auto Clock Set function is activated whenever the VCR is turned off. The date and time is adjusted automatically by making reference to the time signal from the station whose programme position is displayed in the “**CLOCK PROG**” row.

If you do not need the Auto Clock Set function, select **OFF**.

Note

- The menu disappears automatically if you don't proceed for more than a few minutes.

Manual setup — Selecting a language

You can change the on-screen display language from the one you selected with the Auto Set Up function.

Before you start...

- Turn on the VCR and the TV.
- Set the TV to the video channel.

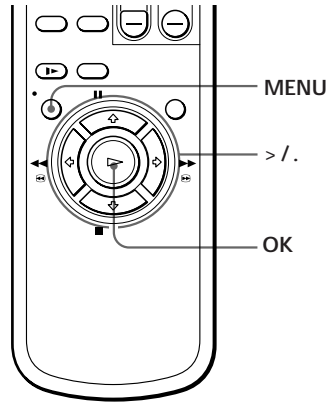

- 1** • **MENU** Press MENU, then press > / . to select SETTINGS and press OK.

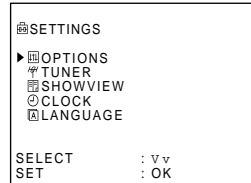
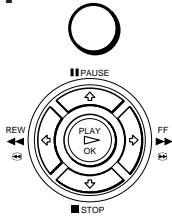

- 2** Press > / . to select LANGUAGE, then press OK.

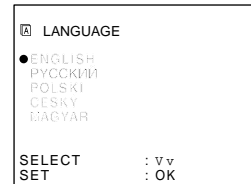
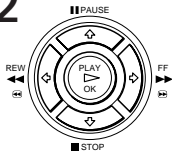

- 3** Press > / . to move the dot (•) to the desired language, then press OK.

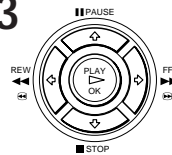

Manual setup — Presetting channels

If some channels could not be preset using the Auto Set Up function, you can preset them manually.

Before you start...

- Turn on the VCR and the TV.
- Set the TV to the video channel.

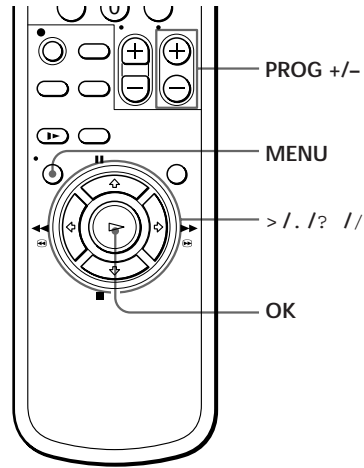

1 ●MENU

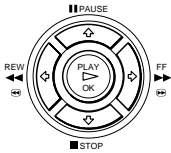

Press MENU, then press > / . to select SETTINGS and press OK.

⊞ SETTINGS	
▶ ⊞ OPTIONS	
⊞ TUNER	
⊞ SHOWVIEW	
⊞ CLOCK	
⊞ LANGUAGE	
SELECT	: V v
SET	: OK

2 ■PAUSE



Press > / . to select TUNER, then press OK.

⊞ TUNER	PROG14
SYSTEM	[D/K]
NORMAL/CATV	[CATV]
▶ CHANNEL SET	[S01]
AFT FINE TUNING	[ON]
SELECT	: V v
SET	: B b

3 ■PAUSE



Press > / . to move the cursor () to NORMAL/CATV, then select either NORM or CATV using ? // .

⊞ TUNER	PROG14
SYSTEM	[D/K]
▶ NORMAL/CATV	[NORM]
CHANNEL SET	[S01]
AFT FINE TUNING	[ON]
SELECT	: V v
SET	: B b

4 ■PAUSE



Press > / . to move the cursor () to CHANNEL SET.

⊞ TUNER	PROG14
SYSTEM	[D/K]
NORMAL/CATV	[NORM]
▶ CHANNEL SET	[S01]
AFT FINE TUNING	[ON]
SELECT	: V v
SET	: B b

5

•PROG

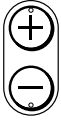

Press PROG +/- to select the programme position.

Selected programme position

TUNER	PROG 7
SYSTEM	[D/K]
NORMAL/CATV	[NORM]
▶CHANNEL SET	[S01]
AFT FINE TUNING	[ON]
SELECT	: V v
SET	: B b

6

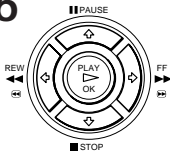

Press ? // repeatedly until the channel you want is displayed.

TUNER	PROG 7
SYSTEM	[D/K]
NORMAL/CATV	[NORM]
▶CHANNEL SET	[C02]
AFT FINE TUNING	[ON]
SELECT	: V v
SET	: B b

The channels appear in the following order.

D/K TV system		B/G TV system	
CHANNEL SET number	Corresponding TV channel	CHANNEL SET number	Corresponding TV channel
2	R1	2	E2
5	R6	3	E3
6	R7	4	E4
12	R12	5	E5
13	R2	6	E6
14	R3	7	E7
15	R4	8	E8
16	R5	9	E9
17	R8	10	E10
18	R9	11	E11
19	R10	12	E12
20	R11	21-69	E21-E69
21-69	R21-R69	CATV 1-41	S1-S41
		CATV 42-46	S01-S05

If you know the number of the channel you want, press the programme number buttons. For example, for channel 5, first press "0" and then press "5."

7

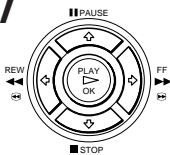

If the TV sound is distorted or noisy, press > / . to move the cursor () to SYSTEM, then select B/G or D/K so that you get the better sound.

TUNER	PROG 7
▶SYSTEM	[B/G]
NORMAL/CATV	[NORM]
CHANNEL SET	[C02]
AFT FINE TUNING	[ON]
SELECT	: V v
SET	: B b

continued

Manual setup — Presetting channels (continued)

- 8** To allocate another channel to another programme position, repeat steps 3 to 7.

- 9** Press OK.

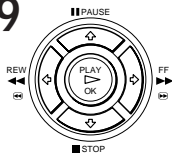

Disabling unwanted programme positions

After presetting the channels, you can disable unused programme positions. The disabled positions will be skipped later when you press the PROG +/- buttons.

- 1 In step 6 above, press programme number button “0” twice to display the number “00” beside CHANNEL SET.
- 2 Press OK.

If the picture is not clear

Normally, the Auto Fine Tuning (AFT) function automatically tunes in channels clearly. If, however, the picture is not clear, you may also use the manual tuning function.

- 1 Press PROG +/- to select the programme position for which you cannot obtain a clear picture.
 - 2 Press MENU, then select SETTINGS and press OK.
 - 3 Select TUNER and press OK.
 - 4 Select FINE TUNING. The fine tuning meter appears.
 - 5 Press ? // to get a clearer picture, then press OK. The menu disappears.
- Note that the AFT (Auto Fine Tuning) setting switches to OFF.

Selected programme position

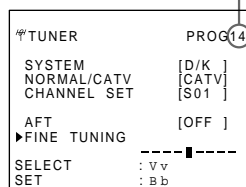

Note

- The menu disappears automatically if you don't proceed for more than a few minutes.

Manual setup — Setting up ShowView

(SLV-E480EG/E380EG only)

ShowView is a feature that simplifies programming the VCR to make timer recordings. To use ShowView, each programme position needs to be matched with its ShowView guide channel. To get the guide channel numbers, look in the programme guide for your area that features ShowView numbers.

- If you want to record satellite broadcasts using ShowView, see page 22 .

Before you start...

- Turn on the VCR and the TV.
- Set the TV to the video channel.

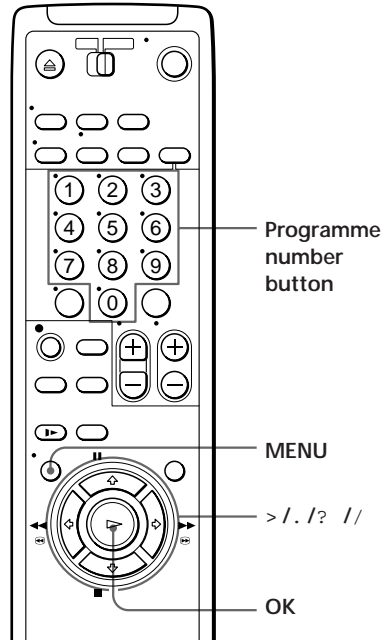

- 1** • **MENU** Press MENU, then press > / . to select SETTINGS and press OK.

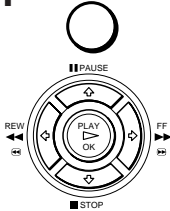

SETTINGS	
▶	OPTIONS
⌘	TUNER
⌘	SHOWVIEW
⌘	CLOCK
⌘	LANGUAGE
SELECT	: V v
SET	: OK

- 2** Press > / . to select SHOWVIEW and press OK.
- The preset channels are displayed on the screen. “- - -” in the GUIDE CH column means that the guide channel has not been preset.

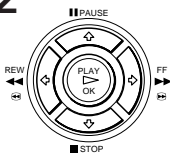

SHOWVIEW		
▶	PROG	CH
1	C01	> - - - <
2	C02	> - - - <
3	C03	> - - - <
4		> - - - <
5	S15	> - - - <
SELECT	: V v	
SET	: 0-9	
CANCEL	: CLEAR	

continued

Manual setup — Setting up ShowView (continued)

3

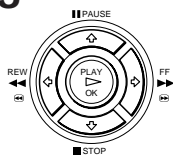

Press > / . to move the cursor () to the row on which you want to set the guide channel.

To display other pages for programme positions 6 to 60, press > / . repeatedly.

SHOWVIEW		
PROG	CH	GUIDE CH
1	C01	---
2	C02	+++
▶ 3	C03	---
4		+++
5	S15	---
SELECT		: V V
SET		: 0-9
CANCEL		: CLEAR

4

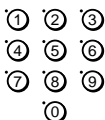

Press programme number buttons to enter the guide channel number assigned in the programme guide.

SHOWVIEW		
PROG	CH	GUIDE CH
1	C01	---
2	C02	+++
▶ 3	C03	123
4		+++
5	S15	---
SELECT		: V V
SET		: 0-9
CANCEL		: CLEAR

5

To set the guide channel of another station, repeat steps 3 to 4.

6

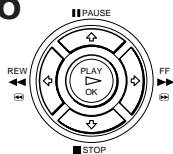

Press OK.

Setting up ShowView for satellite broadcasts

When your satellite tuner is connected via the AERIAL IN connector, first you have to set the programme position for each satellite channel using the TUNER menu. Then set the guide channel number for each satellite channel using the SHOWVIEW menu.

If your satellite tuner is connected via the LINE-1(TV) connector, you don't have to set programme positions nor guide channel numbers for satellite channels. Skip the following procedure.

- 1 Turn on the satellite tuner.
- 2 Press MENU, then select SETTINGS and press OK.
- 3 Select TUNER and press OK.
- 4 Press PROG +/- to select a programme position you want to use for watching a satellite channel.

- 5** Select CHANNEL SET, then press ? // repeatedly to tune the VCR to the satellite tuner.

The channel number displayed beside CHANNEL SET is used for receiving all satellite broadcasts from the satellite tuner.

# TUNER	PROG 6
SYSTEM	[D/K]
NORMAL/CATV	[CATV]
▶ CHANNEL SET	[S30]
AFT FINE TUNING	[ON]
SELECT	: V V
SET	: B B

- 6** Press PROG +/- to select another programme position for the next satellite channel, and press the programme number buttons to enter the same channel number as the one displayed in step 5.

Repeat this step for all satellite channels.

- 7** Set the guide channel number for each programme position assigned to the satellite channel, following the procedures on pages 21 and 22.

Notes

- The menu disappears automatically if you don't proceed for more than a few minutes.
- If you use a satellite tuner connected via the LINE-1 (TV) connector, you don't have to set up ShowView. Just record a satellite programme using ShowView, and the VCR automatically records the programme from the LINE-1 (TV) connector.
- If you inadvertently entered a guide channel number, press CLEAR.
- The VCR does not allow entering the guide channel number if the same number has been set.
- When you record a satellite broadcast using ShowView, you need to select the desired channel on the satellite tuner manually.

Playing a tape

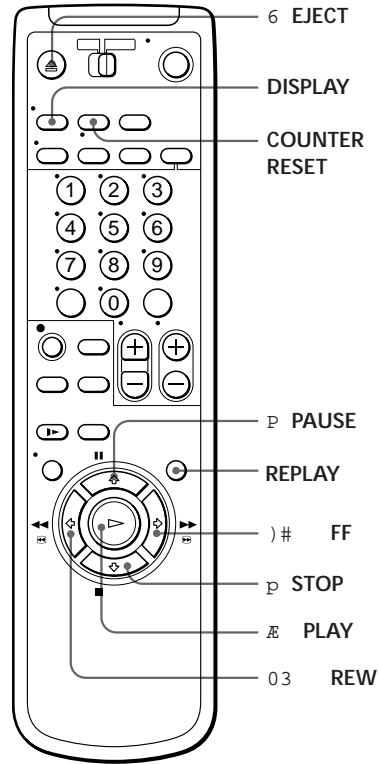
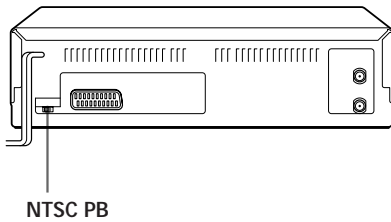

1 Turn on your TV and set it to the video channel.

2 Insert a tape.
The VCR turns on and starts playing automatically if you insert a tape with its safety tab removed.

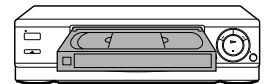

3 Press **PLAY**.
When the tape reaches the end, it will rewind automatically.



Additional tasks

To	Press
Stop play	⏏ STOP
Pause play	⏏ PAUSE
Resume play after pause	⏏ PAUSE or ⏏ PLAY
Fast-forward the tape)# FF during stop
Rewind the tape	03 REW during stop
Eject the tape	⏏ EJECT

To replay a recently watched scene

You can immediately rewind and playback the scene you want to watch again.

During playback, press REPLAY up to four times. The VCR rewinds the tape about 10 seconds on the counter for each press of the button, and restarts playback.

To play an NTSC-recorded tape

Set NTSC PB at the rear of the VCR according to the colour system of your TV.

When your TV is	Set NTSC PB to
PAL only	ON PAL TV
PAL and NTSC	NTSC 4.43

To use the time counter

At the point on the tape that you want to find later, press COUNTER RESET. The counter in the display window resets to "0:00:00." Search for the point afterwards by referring to the counter.



To display the counter on the TV screen, press DISPLAY.

continued

Playing a tape (continued)

Notes

- Tapes recorded in the LP mode can be played back on this VCR (SLV-E480EG/E477EG only).
- The counter resets to “0:00:00” whenever a tape is reinserted.
- The counter stops counting when it comes to a portion with no recording.
- When you play back the tape recorded with the NTSC colour system, the counter does not appear on the TV screen.
- Depending on your TV, the following may occur while playing an NTSC-recorded tape:
 - The picture becomes black and white.
 - The picture shakes.
 - No picture appears on the TV screen.
 - Black streaks appear horizontally on the TV screen.
 - The colour density increases or decreases.
 - Deterioration of the picture quality may occur.
- If a tape has portions recorded in both PAL and NTSC systems, the time counter reading will not be correct. This is due to the difference between the counting cycles of the two video systems.
- While setting the menu on the TV screen, buttons for playback do not function.

Recording TV programmes

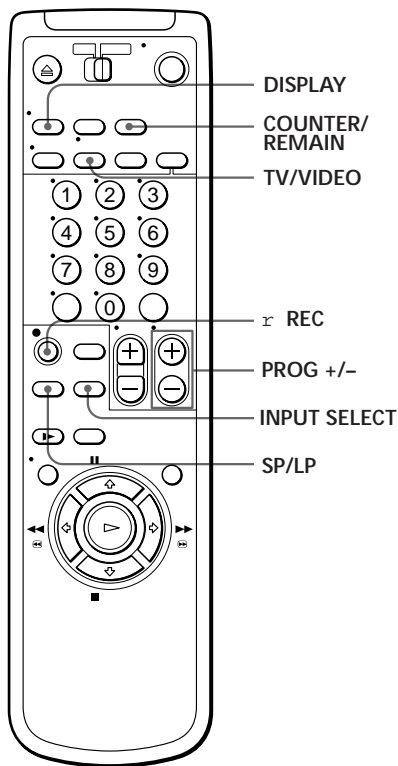

1 Turn on your TV and set it to the video channel.

2 Insert a tape with its safety tab in place.

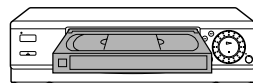

3 Press INPUT SELECT until a programme position number appears in the display window.



continued

Recording TV programmes (continued)

- 4** ●PROG Press PROG +/- to select the programme position you want to record.

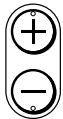

- 5** SP/LP (SLV-E480EG/SLV-E477EG only)
Press SP/LP to select the tape speed, SP or LP.



LP (Long Play) provides recording time twice as long as SP (Standard Play), however, SP produces better picture and audio quality.



- 6** ●REC Press r REC to start recording.
The recording indicator lights up red in the display window.



Recording indicator

To stop recording

Press p STOP.

To check the remaining time

Press DISPLAY. With the display on, press COUNTER/REMAIN to check the remaining time. Each time you press COUNTER/REMAIN, the time counter and the remaining time appear alternately. The remaining time with the  indicator also appears in the display window.

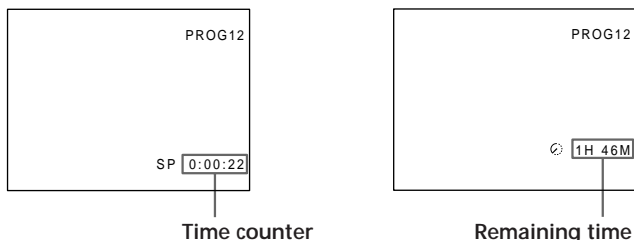

To correctly check the remaining time of the tape, set TAPE SELECT in the TAPE OPTIONS menu according to the tape type you use (see page 44).

To watch another TV programme while recording

- 1 Press TV/VIDEO to turn off the VIDEO indicator in the display window.
If the TV is connected to the VCR using only the aerial cable, skip this step.
- 2 Select another programme position on the TV.

To save a recording

To prevent accidental erasure, break off the safety tab as illustrated. To record on a tape again, cover the tab hole with adhesive tape.



continued

Recording TV programmes (continued)

Tips

- To select a programme position, you can use the programme number buttons on the remote commander. For two-digit numbers, press the ? (ten's digit) button followed by the programme number buttons.
- You can select a video source from the LINE-1 (TV) jacks using INPUT SELECT or PROG +/- . When you use PROG +/-, "L" appears in the display window between the lowest programme position and the highest one.
- The display appears on the TV screen indicating information about the tape, but the information won't be recorded on the tape.
- If you don't want to watch TV while recording, you can turn off the TV.

Notes

- The display does not appear during still (pause) mode or slow-motion playback.
- The display will not appear while playing an NTSC-recorded tape.
- If a tape has portions recorded in both PAL and NTSC systems, the time counter reading will not be correct. This discrepancy is due to the difference between the counting cycles of the two video systems.
- When you insert a non-standard commercially available tape, the remaining time may not be correct.
- The remaining time doesn't work for an NTSC-recorded tape. "--:--" appears in the display window.
- The remaining time is intended for rough measurement only.
- If you play back the tape for about 30 seconds after you have inserted it, the remaining time will be displayed.

Recording TV programmes using ShowView

(SLV-E480EG/E380EG only)

Just enter the programme's ShowView number listed in the TV programme guide. The date, times, and programme position of that programme are set automatically. You can preset up to eight programmes at a time.

Before you start...

- Check that the VCR clock is set to the correct time.
- Insert a tape with its safety tab in place. Make sure the tape is longer than the total recording time.

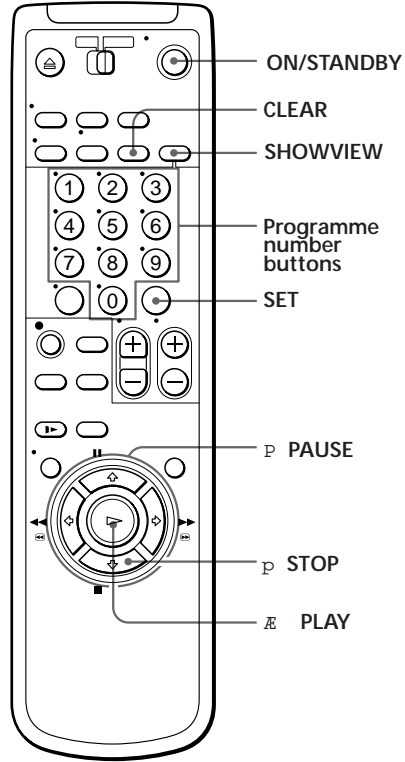

1 SHOWVIEW  Press SHOWVIEW.

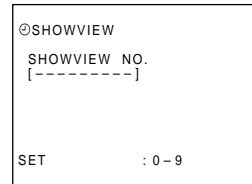

continued

Recording TV programmes using ShowView (continued)

2

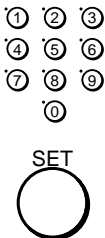

Press the programme number buttons to enter the programme's ShowView number, then press SET.

If you make a mistake, press SHOWVIEW before pressing SET and re-enter the correct number.

The date, start and stop times, programme position, tape speed (SLV-E480EG only), and the VPS/PDC function setting (SLV-E380EG only) appear on the TV screen.

If the information is incorrect, press CLEAR to cancel the setting.

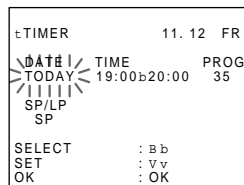

3

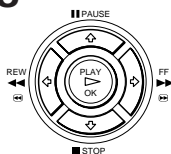

If you want to change the date, tape speed, and the VPS/PDC function setting:

- 1 Press ? // to flash the item you want to change.
- 2 Press > / . to reset it.

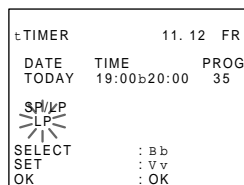

- To record the same programme every day or the same day every week, see "Daily/weekly recording" on page 33.
- To use the VPS/PDC function on SLV-E380EG, see "Timer recording with VPS/PDC signals" on page 33.

4

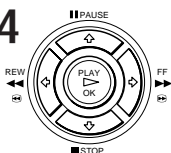

Press OK to complete the setting.

5



Press ON/STANDBY to turn off the VCR.

The  indicator appears in the display window and the VCR stands by for recording.

To stop recording

To stop the VCR while recording, press **p** STOP.

Daily/weekly recording

In step 3 above, press . to select the recording pattern. Each time you press . , the indication changes as shown below. Press > to change the indication in reverse order.

TODAY n SU-SA (Sunday to Saturday) n MO-SA (Monday to Saturday) n
 MO-FR (Monday to Friday) n SA (every Saturday)
 n MO (every Monday) n SU (every Sunday) n 1 month later n (dates
 count down) n TODAY

Timer recording with VPS/PDC signals (SLV-E380EG only)

The broadcast systems transmit VPS (Video Programme System) or PDC (Programme Delivery Control) signals with their TV programmes. These signals ensure that your timer recordings are made regardless of broadcast delay, early starts or broadcast interruptions.

To use the VPS/PDC function, set VPS/PDC to ON. You can also use the VPS/PDC function for a source connected to the LINE-1(TV) connector.

To record satellite broadcasts

If you connect the satellite tuner and the VCR, you can record satellite programmes.

- 1** Turn on the satellite tuner.
- 2** On the satellite tuner, select the satellite programme for which you want to make a timer setting.
- 3** Keep the satellite tuner turned on until the VCR finishes recording the satellite programme for which you have made a timer setting.

To use the VCR after setting the timer

To use the VCR before a timer recording begins, just press ON/STANDBY.

The ☺ indicator turns off and the VCR switches on. Remember to press ON/STANDBY to reset the VCR after using the VCR.

You can also do the following tasks while the VCR is recording:

- Reset the counter.
- Display tape information on the TV screen.
- Check the timer settings.
- Watch another TV programme.

continued

Recording TV programmes using ShowView (continued)

Tips

- For SLV-E480EG, you can also use the SP/LP button to set the tape speed.
- For SLV-E480EG, when you are recording a programme in the SP mode and the remaining tape becomes shorter than the recording time, the tape speed is automatically changed to the LP mode. Note that some interference will appear on the picture at the point the tape speed is changed. If you want to keep the same tape speed, set AUTO TAPE SPEED to OFF in the OPTIONS menu (page 44).

Note

- If the ShowView number is incorrect, the SHOWVIEW menu appears instead of the TIMER menu after pressing SET.

Setting the timer manually

If ShowView is not available in your area, follow the instructions below to set the timer to record programmes.

Before you start...

- Check that the VCR clock is set to the correct time.
- Insert a tape with its safety tab in place. Make sure the tape is longer than the total recording time.
- Turn on your TV and set it to the video channel.

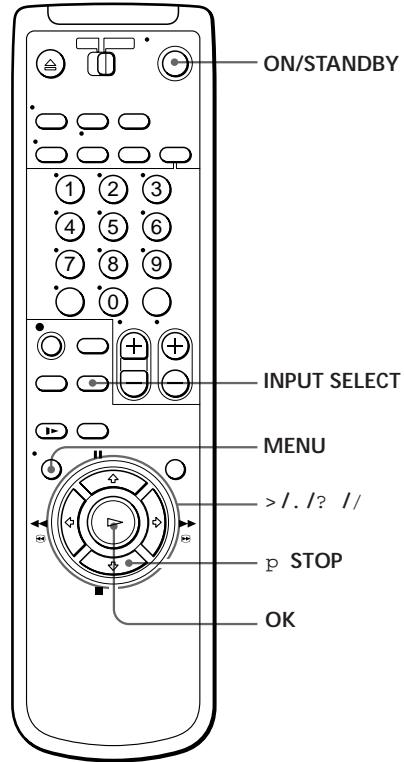

1 • MENU

Press MENU, then press >/. to select **TIMER** and press OK.

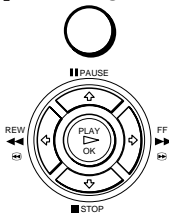

⏸ TIMER	11. 12	FR
DATE	TIME	PROG
TODAY	19:00b20:00	35
SP/LP		
SP		
SELECT	: B b	
SET	: V v	
OK	: OK	

continued

Setting the timer manually (continued)

2

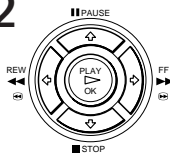

Set the date, programme position, start and stop times, tape speed (SLV-E480EG/ E477EG only) and VPS/PDC function (SLV-E380EG only):

- 1 Press ? // to flash each item in turn.
- 2 Press > / . to set each item.

To correct a setting, press ? to return to that setting and reset.

- To record the same programme every day or the same day every week, see “Daily/weekly recording” on page 37.
- To use the VPS/PDC function on SLV-E380EG, see “Timer recording with VPS/PDC signals” on page 37.
- To record from a source connected to the LINE-1 (TV) connector, press INPUT SELECT to display “L” in the “PROG” position.

tTIMER	11. 12	FR
DATE	TIME	PROG
TODAY	19:00b20:00	35
SP/LP LP		
SELECT	:	B b
SET	:	V v
OK	:	OK

3

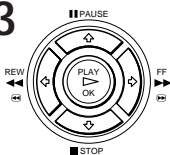

Press OK.

4



Press ON/STANDBY to turn off the VCR.

The  indicator appears in the display window and the VCR stands by for recording.

To record from a source, leave the connected equipment switched on.

To stop recording

To stop the VCR while recording, press  STOP.

To use the VCR after setting the timer

To use the VCR before a timer recording begins, just press ON/STANDBY. The  indicator turns off and the VCR switches on. Remember to press ON/STANDBY to reset the VCR after using the VCR.

You can also do the following tasks while the VCR is recording:

- Reset the counter.
- Display tape information on the TV screen.
- Check the timer settings.
- Watch another TV programme.

Daily/weekly recording

In step 2 above, press **.** to select the recording pattern. Each time you press **.**, the indication changes as shown below. Press **>** to change the indication in reverse order.

TODAY **n** SU-SA (Sunday to Saturday) **n** MO-SA (Monday to Saturday) **n**
 MO-FR (Monday to Friday) **n** SA (every Saturday)
n MO (every Monday) **n** SU (every Sunday) **n** 1 month later **n** (dates
 count down) **n** TODAY

Timer recording with VPS/PDC signals (SLV-E380EG only)

The broadcast systems transmit VPS (Video Programme System) or PDC (Programme Delivery Control) signals with their TV programmes. These signals ensure that your timer recordings are made regardless of broadcast delay, early starts or broadcast interruptions.

To use the VPS/PDC function, set VPS/PDC to ON. You can also use the VPS/PDC function for a source connected to the LINE-1(TV) connector.

Tips

- To set the programme position, you can also use the PROG +/- or programme number buttons.
- For SLV-E480EG/E477EG, you can also use the SP/LP button to set the tape speed.
- For SLV-E480EG/E477EG, when you are recording a programme in the SP mode and the remaining tape becomes shorter than the recording time, the tape speed is automatically changed to the LP mode. Note that some interference will appear on the picture at the point the tape speed is changed. If you want to keep the same tape speed, set AUTO TAPE SPEED to OFF in the OPTIONS menu (page 44).

Notes

- For SLV-E380EG, when setting the timer with VPS/PDC signals, enter the start and stop times exactly as indicated in the TV programme guide, otherwise the VPS/PDC function won't work.
- If the VPS/PDC signal is too weak or the broadcasting station failed to transmit VPS/PDC signals, the VCR will start recording at the set time without using the VPS/PDC function.
- The  indicator flashes in the display window when you press ON/STANDBY with no tape inserted.

Playing/searching at various speeds

SLV-E480EG/E477EG

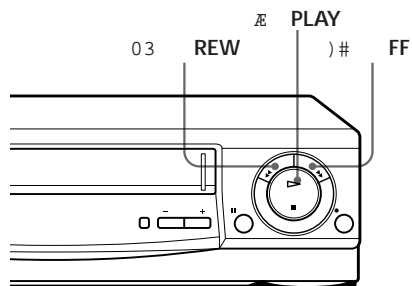

SLV-E380EG

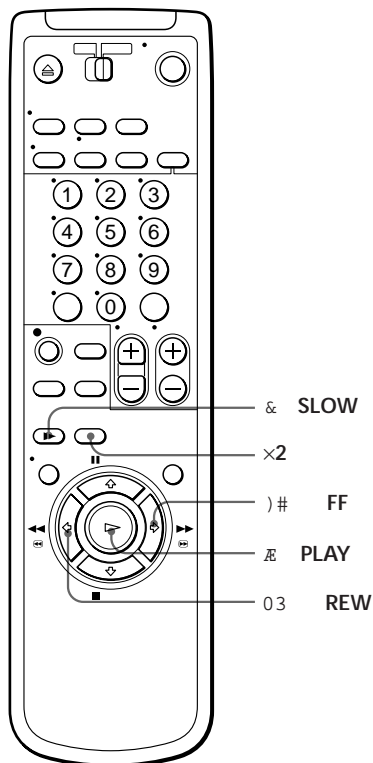
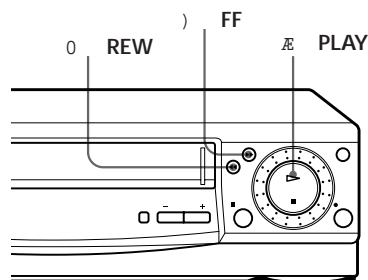

Playback options	Operation
View the picture during fast-forward or rewind	During fast-forward, hold down)# FF or) FF. During rewind, hold down 03 REW or 0 REW.
Play at high speed	<ul style="list-style-type: none"> • During playback, press)# FF or 03 REW. • During playback, hold down)# FF or 03 REW. To resume normal playback, release the button.
Play at twice the normal speed (SLV-E480EG/E477EG only)	During playback, press x2
Play in slow motion	During playback or pause, press & SLOW.
Play frame by frame	During pause, press)# FF or 03 REW. Hold down the button to play one frame each second.
Rewind and start play	During stop, press Æ PLAY on the VCR while holding down 0 REW or 03 REW on the VCR.

To resume normal playback
Press Æ PLAY.

Using the CLICK SHUTTLE ring (SLV-E380EG only)

With the CLICK SHUTTLE ring, you can operate a variety of playback options.

During playback or pause, turn the CLICK SHUTTLE ring clockwise or counterclockwise. Each change in the CLICK SHUTTLE ring position changes the playback mode in the following way.

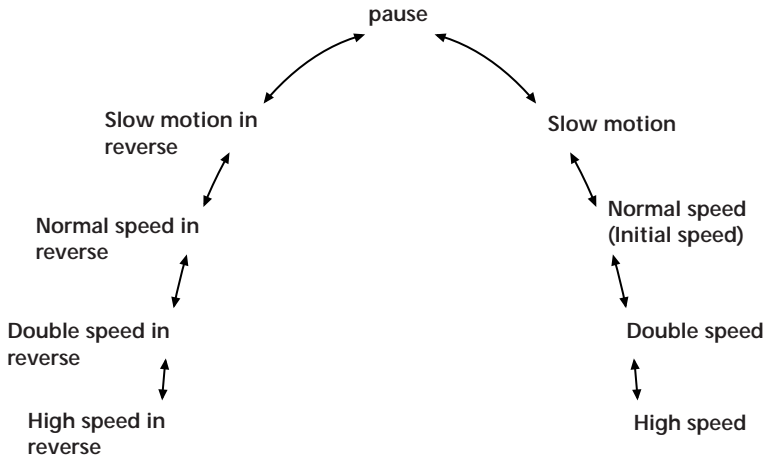
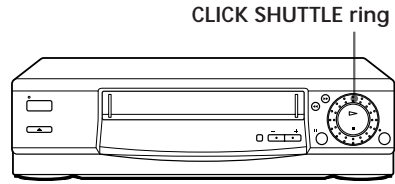

Tip

- Adjust the picture using the TRACKING +/- buttons on the VCR if:
 - streaks appear while playing in slow motion
 - the picture shakes while pausing.

To set tracking to the centre position, press both buttons (+/-) at the same time.

Notes

- The sound is muted during these operations.
- The picture may have a snow:
 - when playing at high speed in reverse
 - when playing in reverse slow motion
 - when playing in reverse.

Recording TV programmes using the quick timer

After starting recording in the normal way, you can have the VCR stop recording automatically after a specified duration.

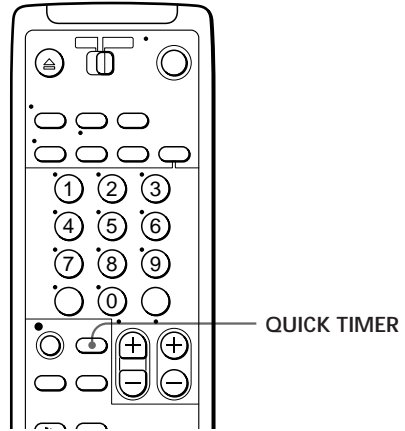

- 1 While recording, press QUICK TIMER once.
The ⏸ indicator appears in the display window.



- 2 Press QUICK TIMER repeatedly to set the duration.
Each press advances the time in increments of 30 minutes. For SLV-E380EG, you can specify the duration up to 6 hours, and for SLV-E480EG/E477EG, up to 11 hours.

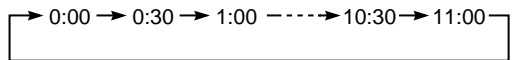

The duration decreases minute by minute to 0:00, then the VCR stops recording and turns off automatically.

To extend the duration

Press QUICK TIMER repeatedly to set to the new duration.

To stop recording

To stop the VCR while recording, press **P** STOP.

Using the quick timer during stop mode

You can set the quick timer and start recording during stop mode by pressing QUICK TIMER. To set the channel, you can use the PROG +/- or INPUT SELECT buttons. Press QUICK TIMER repeatedly to set the recording duration. The recording will start automatically.

Checking/ changing/ cancelling timer settings

Before you start...

- Turn on your TV and set it to the video channel.

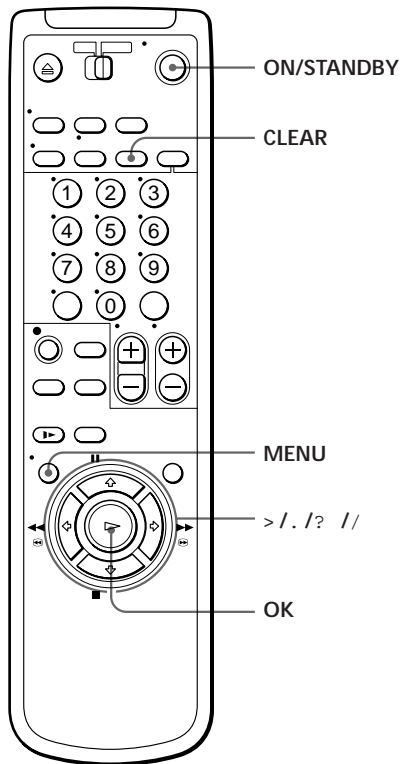

- 1 Press ON/STANDBY to turn on the VCR.
- 2 Press MENU, then press > / . to select LIST and press OK:

- If you want to change a setting, go on to the next step.
- If you do not need to change or cancel the settings, press OK, then turn off the VCR to return to recording standby.

eLIST	TIME	11. 12	FR
DATE	1900b2000	6	SP
▶TU	0930b1000	35	SP
11. 12	0500b0530	44	LP
MO-FR	1200b1300	L	LP
MO-SA	2300b2330	L	SP
SU-SA	1212b1313	27	LP
---	---	---	---

- 3 Press > / . to select the setting you want to change or cancel, then press OK.

continued

Checking/changing/cancelling timer settings (continued)

- 4
- To change the setting, press ? // to flash the item you want to change, and press > / . to reset it.
 - To cancel the setting, press CLEAR.

€TIMER	11.12	FR
DATE	TIME	PROG
TODAY	19:00b20:00	35
SH/MP		
LP		
SELECT	: B b	
SET	: V v	
OK	: OK	

- 5 Press OK.

If any settings remain, turn off the VCR to return to recording standby.

When the timer settings overlap

The programme that starts first has priority and the second programme starts recording only after the first programme has finished. If the programmes start at the same time, the programme listed first in the menu has priority.

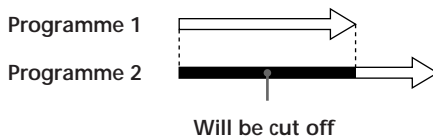

Adjusting the picture

Adjusting the tracking

Although the VCR automatically adjusts the tracking when playing a tape (the  indicator flashes in the display window, then goes off), distortion may occur if the tape was recorded in poor condition. If so, manually adjust the tracking.

During playback, press the TRACKING +/- buttons on the VCR to display the tracking meter. The distortion should disappear as you press one of the two buttons. (The  indicator lights up.) To resume automatic tracking adjustment eject the tape and restart it.

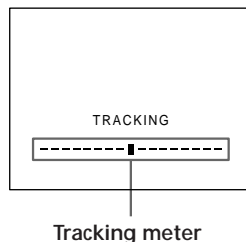

About Optimum Picture Control (OPC)

Optimum Picture Control (OPC) automatically improves recording and playback quality by adjusting the VCR to the condition of the video heads and tape. To maintain better picture quality, we recommend that you set OPC to ON in the VIDEO OPTIONS menu (with the OPC indicator in the display window lit). For details, see page 44.

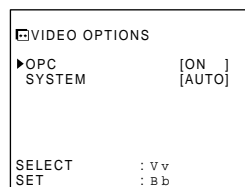

OPC playback

The OPC function automatically works on all types of tapes, including rental tapes and tapes that were not recorded with OPC.

OPC recording

Whenever you insert a tape and first start recording, the VCR adjusts to the tape using the OPC function (the OPC indicator flashes rapidly). This adjustment is retained until the tape is ejected.

To deactivate the OPC

Press MENU and select SETTINGS, OPTIONS, VIDEO OPTIONS then set OPC to OFF. The OPC indicator in the display window goes off.

Note

- There is a delay of a few seconds before the VCR actually starts recording while the VCR analyses the tape. To avoid the delay, first set the VCR to recording pause (the OPC indicator flashes slowly) and press **r** REC to have the VCR analyse the tape. After the OPC indicator stops flashing, press **P** PAUSE to start recording immediately. If you press **P** PAUSE before the OPC indicator stops flashing, the OPC function is cancelled.

Changing menu options

- 1 Press MENU, then press > / . to select SETTINGS and press OK.

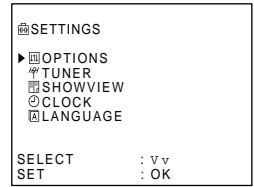

- 2 Press > / . to select OPTIONS, then press OK.

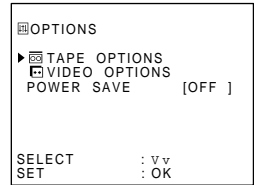

- 3 Press > / . to select the option you want to change:
 - To change the TAPE OPTIONS or VIDEO OPTIONS
 - 1 Press OK after selecting TAPE OPTIONS or VIDEO OPTIONS.
 - 2 Press > / . to select the option, then press ? // to change the setting.
 - To change the other options, press ? // to change the setting.
- 4 Press OK to return to the original screen.

Menu choices

Initial settings are indicated in bold print.

TAPE OPTIONS

Menu option	Set this option to
AUTO TAPE SPEED (SLV-E480EG/ E477EG only)	<ul style="list-style-type: none">• ON to change the timer recording tape speed automatically to the LP mode when the remaining tape becomes shorter than the recording time.• OFF to keep the set tape speed.
TAPE SELECT	<ul style="list-style-type: none">• 300 to use an E-300 type tape.• 240 to use an E-240 type tape.• 195 to use an E-195 or shorter type tape.

VIDEO OPTIONS

Menu option	Set this option to
OPC	<ul style="list-style-type: none">• ON to switch on the OPC (Optimum Picture Control) function and improve picture quality.• OFF to switch off OPC.
SYSTEM	<ul style="list-style-type: none">• AUTO to automatically detect the colour system and play back the tape in the appropriate mode. If the picture's colour is poor, manually select the colour system that the tape was recorded in.• PAL to play back a tape recorded in the PAL system.• MESECAM to play back a tape recorded in the MESECAM system.

Other options

Menu option	Set this option to
POWER SAVE	<ul style="list-style-type: none">• OFF to turn on the indicators in the display window while the VCR is standing by.• ON to turn off the indicators in the display window to conserve the VCR power.

Note

- When you set a timer recording, the indicators in the display window are on even though POWER SAVE is set to ON.

Editing with another VCR

Connecting to record on this VCR

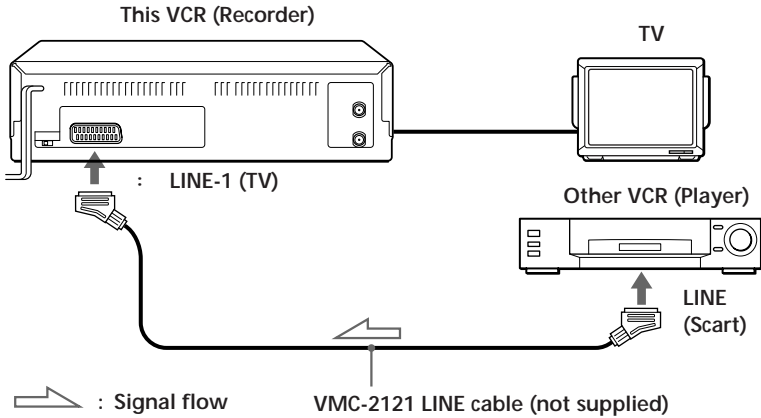

Operation (when recording on this VCR)

Before you start editing

- Turn on your TV and set it to the video channel.
- Press INPUT SELECT to display "L" in the display window.
- Press SP/LP to select the tape speed, SP or LP (SLV-E480EG/E477EG only).

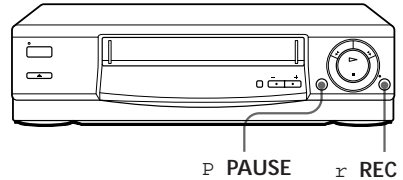

- 1 Insert a source tape with its safety tab removed into the other (playback) VCR. Search for the point to start playback and set it to playback pause.
- 2 Insert a tape with its safety tab in place into this (recording) VCR. Search for the point to start recording and press **P PAUSE**.
- 3 Press **r REC** on this VCR and set it to recording pause.
- 4 To start editing, press the **P PAUSE** buttons on both VCRs at the same time.

To stop editing

Press the **⏏** STOP buttons on both VCRs.

Tips

- To edit more precisely, press the **⏏** PAUSE buttons on the VCRs to release pause.
- To cut out unwanted scenes while editing, press **⏏** PAUSE on this VCR when an unwanted scene begins. When it ends, press **⏏** PAUSE again to resume recording (Assemble Editing).

Note



- If you start recording following the procedure above, the VCR won't start recording with the OPC function. To record a tape with the OPC function, press **r** REC again during recording pause in step 3 so that the VCR analyses the tape. Then, when you start editing in step 4, press **⏏** PAUSE after the OPC indicator stops flashing. If you press **⏏** PAUSE before the OPC indicator stops flashing, the OPC function is cancelled.

Troubleshooting

If you have any questions or problems not covered below, please consult your nearest Sony service facility.

	Symptom	Remedy
Power	The ON/STANDBY switch does not function.	<ul style="list-style-type: none"> Connect the mains lead to mains securely.
	The power is turned on but the VCR does not operate.	<ul style="list-style-type: none"> Moisture condensation occurs. Turn the power off, unplug the mains lead and leave the VCR to dry for over one hour.
Clock	The clock has stopped and “-:-” lights in the display window.	<ul style="list-style-type: none"> The clock stops if the VCR is disconnected from the mains for more than an hour. Reset the clock (and timer).
Playback	The playback picture does not appear on the TV screen.	<ul style="list-style-type: none"> Make sure the TV is set to the video channel. If you are using a monitor, set it to video input.
	The picture is not clear.	<ul style="list-style-type: none"> Adjust the tracking with the TRACKING +/- buttons. The video heads are dirty (see below). Clean the video heads using the Sony T-25CLD, E-25CLDR, or T-25CLW video head cleaning cassette. If these cleaning cassettes are not available in your area, have the heads cleaned at your nearest Sony service facility (a standard service charge will be required). Do not use a commercially available liquid-type cleaning cassette other than Sony’s, as it may damage the video heads. The video heads may have to be replaced. Consult your local Sony service facility for more information.
	The picture rolls vertically during picture search.	<ul style="list-style-type: none"> Adjust the vertical hold control on the TV or monitor.
	The picture has no sound.	<ul style="list-style-type: none"> The tape is defective. Use a new tape.

Symptoms caused by contaminated video heads

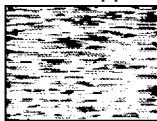
• Normal picture	• Rough picture	• Unclear picture	• No picture (or black & white screen appears)
			
	initial contamination	→ terminal	

	Symptom	Remedy
Recording	No TV programme appears on the TV screen.	<ul style="list-style-type: none"> • Make sure the TV is set to the video channel. If you are using a monitor, set it to video input.
	TV reception is poor.	<ul style="list-style-type: none"> • Adjust the TV aerial. • Make sure the TV system (B/G or D/K) is set to the system in your area.
	The tape starts playing as soon as it is inserted.	<ul style="list-style-type: none"> • The safety tab has been removed. To record on this tape, cover the tab hole.
	The tape is ejected when you press π REC.	<ul style="list-style-type: none"> • Check that the safety tab has not been removed.
Timer recording	Nothing happens when you press π REC.	<ul style="list-style-type: none"> • Make sure the tape is not at its end. • Select the correct source with the INPUT SELECT button. Select a programme position when recording TV programmes; select "L," when recording from other equipment.
	The timer does not operate.	<ul style="list-style-type: none"> • Check that the clock is set. • Make sure a tape has been inserted. • Check that the safety tab has not been removed. • Make sure the tape is not at its end. • Make sure a programme has been set for timer recording. • Make sure your timer settings have not already passed the current time. • The clock stops if the VCR is disconnected from the mains for more than one hour. Reset the clock and timer.

continued

Troubleshooting (continued)

	Symptom	Remedy
Others	A tape cannot be inserted.	<ul style="list-style-type: none">• Check that a tape isn't already in the tape compartment.
	The remote commander does not function.	<ul style="list-style-type: none">• Make sure you are pointing the remote commander at the remote sensor on the VCR.• Replace all the batteries in the remote commander with new ones if they are weak.• Make sure the [TV]/[VIDEO] remote control switch is set correctly.
	The tracking meter does not appear on the screen.	<ul style="list-style-type: none">• The recording condition of the tape is very poor and tracking cannot be adjusted or the NTSC system is being used.
	The VCR needs to be cleaned.	<ul style="list-style-type: none">• Clean the cabinet, panel and controls with a dry, soft cloth, or a soft cloth slightly moistened with a mild detergent solution. Do not use any type of solvent, such as alcohol or benzine.

Specifications

System

Channel coverage

PAL (D/K, B/G)

VHF R1 to R12, E2 to E12

UHF R21 to R69, E21 to E69

CATV S01 to S05, S1 to S41

HYPER S21 to S41

RF output signal

UHF channels 21 to 69

Aerial out

75-ohm asymmetrical aerial socket

Inputs and outputs

: LINE-1 (TV)

21-pin

Video input: pin 20

Audio input: pins 2 and 6

Video output: pin 19

Audio output: pins 1 and 3

General

Power requirements

220 – 240 V AC, 50 Hz

Power consumption

20 W

Operating temperature

5°C to 40°C

Storage temperature

-20°C to 60°C

Dimensions

Approx. 355 × 96 × 285 mm (w/h/d)

including projecting parts and controls

Mass

Approx. 3.9 kg

Supplied accessories

Remote commander (1)

R6 (size AA) batteries (2)

Aerial cable (1)

Design and specifications are subject to change without notice.

Index to parts and controls

Refer to the pages indicated in parentheses () for details.

Front panel (SLV-E480EG/E477EG)

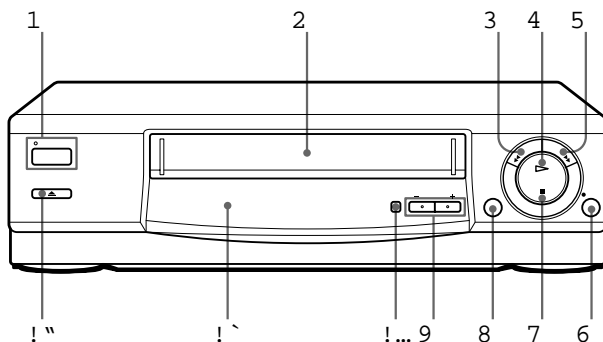

- | | | | |
|---|-------------------------------------|-------|---|
| 1 | ON/STANDBY switch/indicator (8) | 8 | ⏸ PAUSE button (25) |
| 2 | Tape compartment | 9 | PROGRAM/TRACKING +/- buttons (28, 43) |
| 3 | ⏮ REW (rewind) button (25, 38) | !... | AUTO SET UP/RF (Radio Frequency) CHANNEL button (8, 10) |
| 4 | ⏪ PLAY button (24, 38) | !` | Remote sensor (5) |
| 5 | ⏩ FF (fast-forward) button (25, 38) | ! " 6 | EJECT button (25) |
| 6 | ⏹ REC (record) button (28) | | |
| 7 | ⏹ STOP button (25) | | |

Front panel (SLV-E380EG)

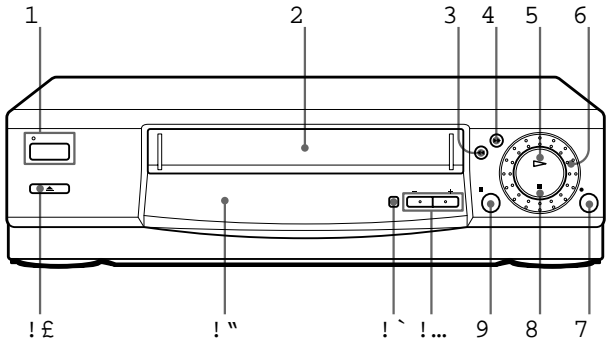

- | | | | |
|---|-----------------------------------|----|---|
| 1 | ON/STANDBY switch/indicator (8) | 9 | PAUSE button (25) |
| 2 | Tape compartment | 0 | PROGRAM/TRACKING +/- buttons (28, 43) |
| 3 | REW (rewind) button (25, 38) | ! | AUTO SET UP/RF (Radio Frequency) CHANNEL button (8, 10) |
| 4 | FF (fast-forward) button (25, 38) | !" | Remote sensor (5) |
| 5 | PLAY button (24, 38) | !£ | EJECT button (25) |
| 6 | CLICK SHUTTLE ring (39) | | |
| 7 | REC (record) button (28) | | |
| 8 | STOP button (25) | | |

continued

Index to parts and controls (continued)

Display window

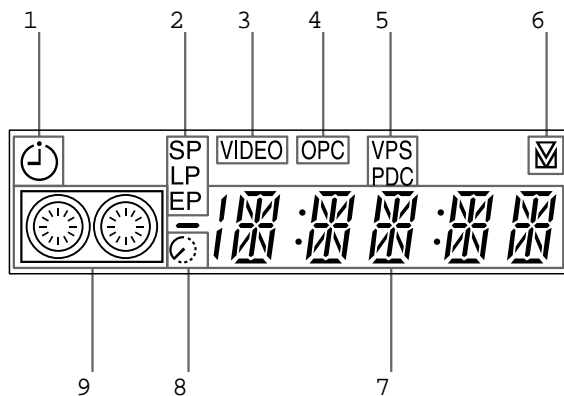

- | | | | |
|---|---|---|--|
| 1 | Timer indicator (36, 40) | 6 | Tracking indicator (43) |
| 2 | Tape speed indicators (28) | 7 | Time counter/clock/line/
programme position indicator
(25, 27, 46) |
| 3 | VIDEO indicator (29) | 8 | Remaining time indicator (29) |
| 4 | OPC (Optimum Picture Control)
indicator (43) | 9 | Tape/recording indicator (28) |
| 5 | VPS (Video Programme System)/
PDC (Programme Delivery Control)
indicator (SLV-E380EG only) (33, 37) | | |

Rear panel

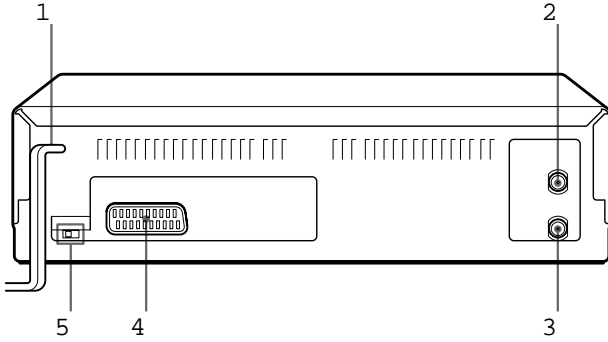

- | | | | |
|---|--|---|----------------------------------|
| 1 | Mains lead (7) | 4 | : LINE-1 (TV) |
| 2 | AERIAL IN
ANTENNE ENTREE connector (7) | | : LIGNE-1 (TV) connector (7, 46) |
| 3 | AERIAL OUT
ANTENNE SORTIE connector (7) | 5 | NTSC PB (PlayBack) switch (25) |

continued

Index to parts and controls (continued)

Remote commander

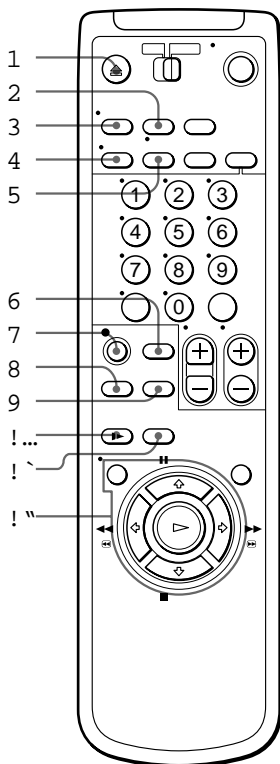

- 1 6 EJECT button (25)
- 2 COUNTER RESET button (25)
- 3 DISPLAY button (25, 29)
- 4 WIDE button (*for TV*) (6)
- 5 TV/VIDEO button (29)
- 6 QUICK TIMER button (40)
- 7 r REC (record) button (28)
- 8 SP (Standard Play)/LP (Long Play) button (SLV-E480EG/E477EG only) (28)
- 9 INPUT SELECT button (27)
- !... & SLOW button (38)
- ! ` x2 button (SLV-E480EG/E477EG only) (38)
- ! \" Tape/menu operation buttons
 - MENU button (12, 44)
 - P PAUSE/> button (12, 25)
 - p STOP/. button (12, 25)
 - 0 3 REW (rewind)/? button (13, 25)
 -) # FF (fast-forward)// button (14, 25)
 - Æ PLAY/OK button (19)

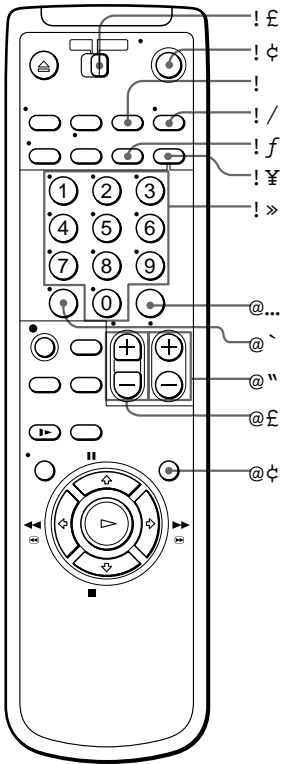

- !£ [TV/VCR] remote control switch (5)
- !¢ ON/STANDBY switch (36)
- ! COUNTER/REMAIN button (29)
- ! / AUDIO MONITOR button (SLV-E477EG only) (6)
- ! f CLEAR button (42)
- ! ¥ SHOWVIEW button (SLV-E480EG/E380EG only) (31)
- ! » Programme number buttons (22)
- @... SET button (SLV-E480EG/E380EG only) (32)
- @` ? (ten's digit) buttons (30)
- @" PROG (programme) +/- buttons (28)
- @£ VOL (volume) +/- buttons (6)
- @¢ REPLAY button (25)

