

Video Cassette Recorder

Operating Instructions



PAL NTSC 4.43

Hi-Fi

VIDEO*plus+*

SLV-E730EX/UX

WARNING

To prevent fire or shock hazard, do not expose the unit to rain or moisture.

To avoid electrical shock, do not open the cabinet. Refer servicing to qualified personnel only.

Mains lead must only be changed at a qualified service shop.

Notice for customers in the United Kingdom and Republic of Ireland

A moulded plug complying with BS1363 is fitted to this equipment for your safety and convenience.

If the 13A fitted plug does not match the outlet socket in your home, please refer to your Appointed Sony Dealer for advice.

Should the fuse in the plug supplied need to be replaced, a 5 AMP fuse approved by ASTA or BSI to BS1362, (i.e., marked with ⚡ or ⚡ mark) must be used.

If the plug supplied with this equipment has a detachable fuse cover, be sure to attach the fuse cover after you change the fuse. Never use the plug without the fuse cover. If you should lose the fuse cover, please contact your nearest Sony service station.

Precautions

Safety

- This unit operates on 220 – 240 V AC, 50 Hz. Check that the unit's operating voltage is identical with your local power supply.
- If anything falls into the cabinet, unplug the unit and have it checked by qualified personnel before operating it any further.
- The unit is not disconnected from the mains as long as it is connected to the mains, even if the unit itself has been turned off.
- Unplug the unit from the wall outlet if you do not intend to use it for an extended period of time. To disconnect the cord, pull it out by the plug, never by the cord.

Installing

- Allow adequate air circulation to prevent internal heat buildup.
- Do not place the unit on surfaces (rugs, blankets, etc.) or near materials (curtains, draperies) that may block the ventilation slots.
- Do not install the unit near heat sources such as radiators or air ducts, or in a place subject to direct sunlight, excessive dust, mechanical vibration or shock.
- Do not install the unit in an inclined position. It is designed to be operated in a horizontal position only.
- Keep the unit and cassettes away from equipment with strong magnets, such as microwave ovens or large loudspeakers.
- Do not place heavy objects on the unit.
- If the unit is brought directly from a cold to a warm location, moisture may condense inside the VCR and cause damage to the video head and tape. When you first install the unit, or when you move it from a cold to a warm location, wait for about one hour before operating the unit.

Caution

Television programmes, films, video tapes and other materials may be copyrighted. Unauthorized recording of such material may be contrary to the provisions of the copyright laws. Also, use of this recorder with cable television transmission may require authorization from the cable television transmitter and/or programme owner.

Compatible colour systems

This VCR is designed to record using the PAL (B/G) colour system and play back using the PAL (B/G) and NTSC 4.43 colour systems. Recording of video sources based on other colour systems cannot be guaranteed.

Table of contents

Getting Started

- 4 Step 1: Unpacking
- 5 Step 2: Setting up the remote commander
- 9 Step 3: Connecting the VCR
- 11 Step 4: Setting up the VCR with the Auto Set Up function
- 12 Step 5: Tuning your TV to the VCR
- 14 Manual setup —
 - Selecting a language, Presetting channels, Setting up VIDEO Plus+*, Setting the clock
- 26 Setting your personal code

Basic Operations

- 28 Playing a tape
- 31 Recording TV programmes
- 35 Recording TV programmes using VIDEO Plus+
- 38 Setting the timer manually

Additional Operations

- 41 Playing/searching at various speeds
- 43 Recording TV programmes using the quick timer
- 44 Checking/changing/cancelling timer settings
- 46 Recording stereo and bilingual programmes
- 48 Searching using the index function
- 49 Adjusting the picture
- 51 Changing menu options
- 53 Editing with another VCR

Additional Information

- 55 Troubleshooting
- 58 Specifications
- 59 Index to parts and controls
- Back cover
- Index

* VIDEO Plus+ and PlusCode are trademarks applied for by Gemstar Development Corp. VIDEO Plus+ system is manufactured under license from Gemstar Development Corporation.

Step 1

Unpacking

Check that you have received the following items with the VCR:

- Remote commander

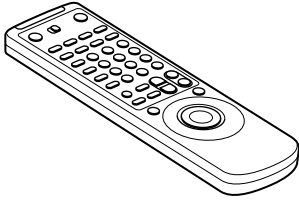

- Aerial cable

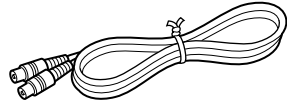

- R6 (size AA) batteries

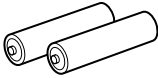

Checking your model name

The instructions in this manual are for the 2 models: SLV-E730EX and E730UX. Check your model number by looking at the rear panel of your VCR. The SLV-E730EX is the model used for illustration purposes. Any difference in operation is clearly indicated in the text, for example, "SLV-E730UX only."

Step 2

Setting up the remote commander

Inserting the batteries

Insert two R6 (size AA) batteries by matching the + and - on the batteries to the diagram inside the battery compartment.

Insert the negative (-) end first, then push in and down until the positive (+) end clicks into position.

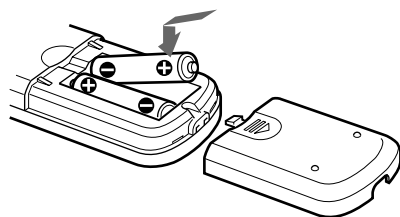

Using the remote commander

You can use this remote commander to operate this VCR and a Sony TV. Buttons on the remote commander marked with a dot (•) can be used to operate your Sony TV.

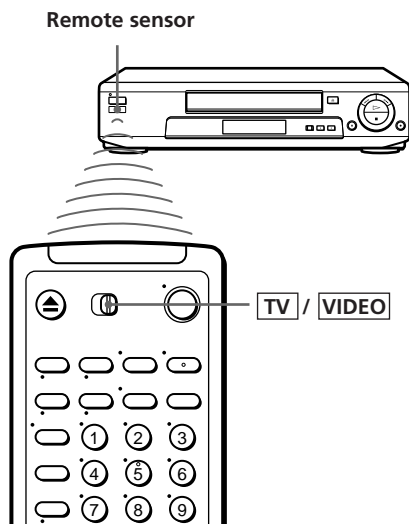

To operate	Set TV / VIDEO to
the VCR	VIDEO and point at the remote sensor on the VCR
a Sony TV	TV and point at the remote sensor on the TV

continued

Step 2 : Setting up the remote commander (continued)

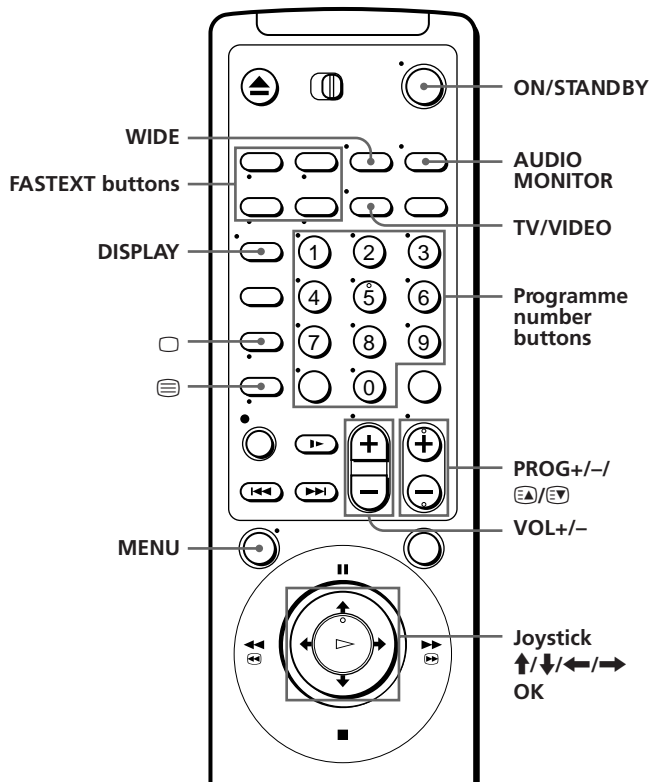

TV control buttons

To	Press
Turn the TV into standby or active mode	ON/STANDBY
Select an input source of the TV either from aerial in or from line in	TV/VIDEO
Select the programme position of the TV	Programme number buttons PROG +/-
Adjust the volume of the TV	VOL +/-
Switch to TV (Teletext off)	□ (TV)
Switch to Teletext	≡ (Teletext)

To	Press
Select the sound	AUDIO MONITOR
Use FASTEXT	FASTEXT buttons
Call up on-screen display	DISPLAY
Change the Teletext page	Ⓔ/Ⓕ
Operate TV menu options	MENU Joystick (↑/↓/←/→, OK)
Switch to/from wide mode of a Sony wide TV (For other manufacture's wide TV, see "Controlling other TVs with the remote commander" below.)	WIDE

Notes

- With normal use, the batteries should last about three to six months.
- If you do not use the remote commander for an extended period of time, remove the batteries to avoid possible damage from battery leakage.
- Do not use a new battery with an old one together.
- Do not use different types of batteries together.

Controlling other TVs with the remote commander

The remote commander is preprogrammed to control non-Sony TVs. If your TV is listed in the table below, set the appropriate manufacturer's code number.

- 1 Set **TV** / **VIDEO** at the top of the remote commander to **TV**.
- 2 Hold down ON/STANDBY, and enter your TV's code number(s) using the programme number buttons. Then release ON/STANDBY.

Now you can use the following TV control buttons to control your TV: ON/STANDBY, TV/VIDEO, programme number buttons, -/-- (ten's digit), PROG +/-, VOL +/-, □ (TV), Ⓔ (Teletext), FASTEXT buttons, WIDE*, MENU*, and the joystick (↑/↓/←/→, OK)*.

* These buttons may not work with all TVs.

Tip

- When you set your TV's code number correctly while the TV is turned on, the TV turns off automatically.

continued

Step 2 : Setting up the remote commander (continued)

Code numbers of controllable TVs

If more than one code number is listed, try entering them one at a time until you find the one that works with your TV.

To make wide mode settings, see the footnotes below this table for the applicable code numbers.

Manufacturer	Code number	Manufacturer	Code number
Sony	01* ¹ , 02	Philips	06* ¹ , 07* ¹ , 08* ¹
Akai	68	Saba	12, 13
Ferguson	52	Samsung	22, 23
Grundig	10* ¹ , 11* ¹	Sanyo	25
Hitachi	24	Sharp	29
Mitsubishi	27* ¹ , 28* ¹ , 50* ¹ , 51* ¹	TEAC	67
NEC	66	Telefunken	36
Nokia	15, 16, 69* ³	Thomson	43* ²
Panasonic	17* ¹ , 49	Toshiba	38

*¹ Press WIDE to switch the wide picture mode on or off.

*² Press WIDE, then press VOL +/- to select the wide picture mode you want.

*³ Press WIDE. The menu appears on the TV screen. Then, push the joystick to //
/ to select the wide picture you want and press the joystick (OK).

Notes

- If the TV uses a different remote control system from the one programmed to work with the VCR, you cannot control your TV with the remote commander.
- If you enter a new code number, the code number previously entered will be erased.
- When you replace the batteries of the remote commander, the code number automatically resets to 01 (Sony). Reset the appropriate code number.

Step 3

Connecting the VCR

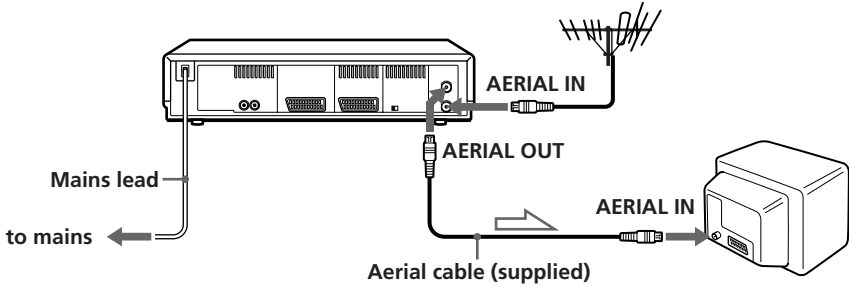

 : Signal flow

1

Disconnect the aerial cable from your TV and connect it to AERIAL IN on the rear panel of the VCR.

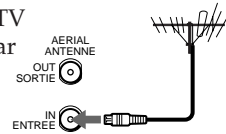

2

Connect AERIAL OUT of the VCR and the aerial input of your TV using the supplied aerial cable.

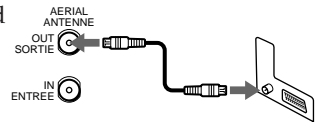

3

Connect the mains lead to the mains.

continued

Step 3 : Connecting the VCR (continued)

Additional connections

To a TV that has a EURO-AV (Scart) connector

This additional connection improves picture and sound quality. Connect the TV as shown on the right. Whenever you want to watch the VCR picture, press TV/VIDEO to display the VIDEO indicator in the display window.

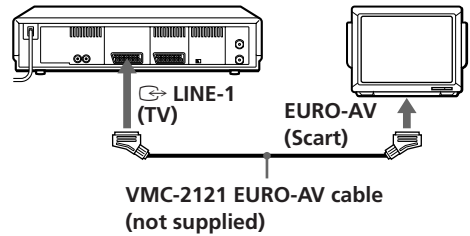

To a stereo system

You can improve sound quality by connecting a stereo system to the AUDIO OUT R/L jacks as shown on the right.

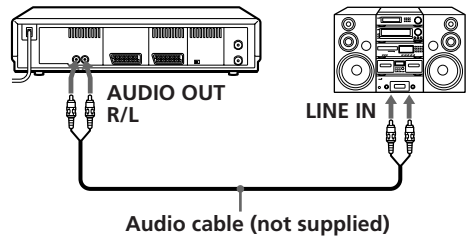

Note

- When you connect the VCR and your TV only with an aerial cable, you have to set RF MODULATOR in the OPTIONS menu to ON (initial setting).
If the TV is connected to the LINE-1 (TV) connector, setting RF MODULATOR in the OPTIONS menu to OFF is recommended. In the OFF position, only the signal from the aerial is output through the AERIAL OUT connector (see page 52).

Step 4

Setting up the VCR with the Auto Set Up function

Before using the VCR for the first time, set up the VCR using the Auto Set Up function. With this function, you can set TV channels, the VCR clock, guide channels for VIDEO Plus+, and the RF channel.

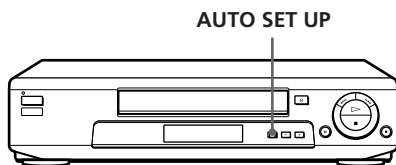

Hold down AUTO SET UP on the VCR for more than three seconds. The VCR automatically turns on, and the ATP (Auto Tuner Preset) function starts searching for all of the receivable channels and presets them in the appropriate order for your local area.



After the search is complete, the current time appears in the display window for any stations that transmit a time signal. If the time does not appear, set the clock manually. See page 22.

To cancel the Auto Set Up function

Press AUTO SET UP.

Note

- Do not cancel the Auto Set Up function during the ATP operations. If you do, repeat the step above.

Step 5

Tuning your TV to the VCR

If you have connected the VCR to your TV using the EURO-AV cable, skip this step.

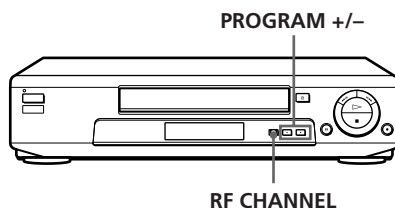

1



Press RF CHANNEL on the VCR.

The factory-preset RF channel appears in the display window.
The VCR signal is output through this channel to the TV.

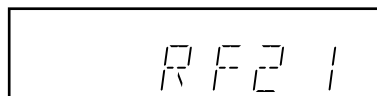

2

Turn on your TV and select a programme position for the VCR picture.

This programme position will now be referred to as the video channel.

3

Tune the TV to the same channel as that shown in the display window so that the picture on the right appears clearly on the TV screen.

Refer to your TV manual for tuning instructions.

If the picture does not appear clearly, see "To obtain a clear picture from the VCR" below.

SONY VIDEO CASSETTE
RECORDER

4

Press RF CHANNEL.

You have now tuned your TV to the VCR. From now on, whenever you want to play a tape, set the TV to the video channel.

To check to see if the TV tuning is correct

Set the TV to the video channel and press PROGRAM +/- on the VCR. If the TV screen changes to a different programme each time you press PROGRAM +/-, the TV tuning is correct.

To obtain a clear picture from the VCR

If the picture does not appear clearly in step 3 above, press PROGRAM +/- in step 3, so that another RF channel appears. Then tune the TV to the new RF channel until a clear picture appears.

Manual setup — Selecting a language

If you prefer an on-screen language other than English, use the on-screen display to select another language.

Before you start...

- Turn on the VCR and the TV.
- Set the TV to the video channel.

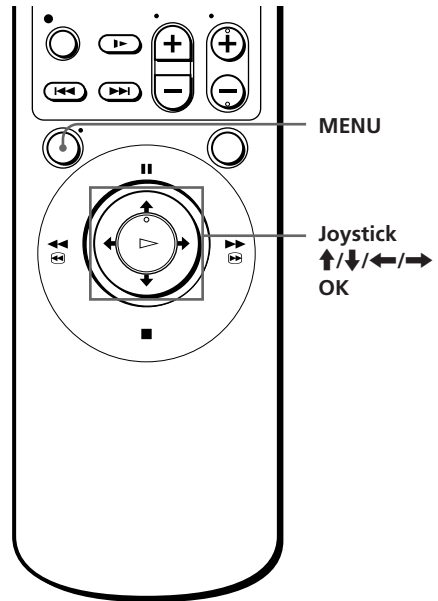

- 1** Press MENU, then push the joystick to ↑/↓ to select SETTINGS and press the joystick (OK).

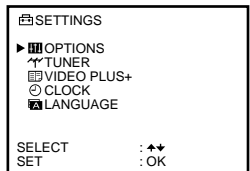
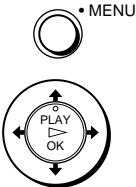

- 2** Push the joystick to ↑/↓ to select LANGUAGE, then press the joystick (OK).

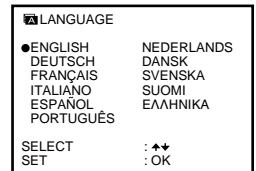

- 3** Push the joystick to ↑/↓/←/→ to move the dot (●) to the desired language, then press the joystick (OK).



Note

- The menu disappears automatically if you don't proceed for more than a few minutes.

Manual setup — Presetting channels

If some channels could not be preset using the Auto Set Up function, you can preset them manually.

Before you start...

- Turn on the VCR and the TV.
- Set the TV to the video channel.

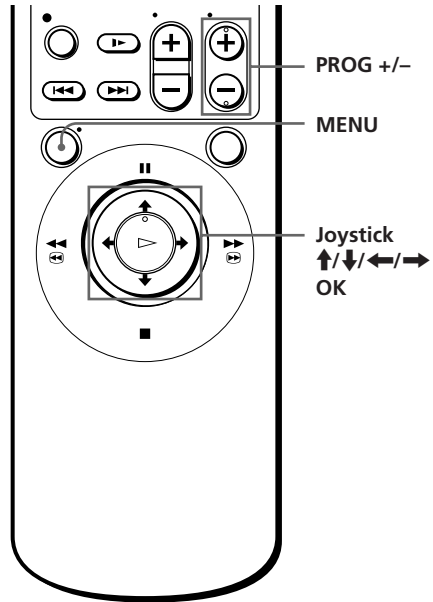

- 1** Press MENU, then push the joystick to **↑/↓** to select SETTINGS and press the joystick (OK).

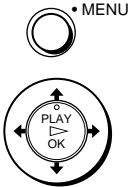

SETTINGS	
▶▶ OPTIONS	
↑ TUNER	
VIDEO PLUS+	
⊙ LOCK	
LANGUAGE	
SELECT	: ↔
SET	: OK

- 2** Push the joystick to **↑/↓** to select TUNER, then press the joystick (OK).



↑ TUNER	PROG10
NORMAL / CATV	[NORM]
▶ CHANNEL SET	[C21]
AFT FINE TUNING	[ON]
SELECT	: ↔
SET	: ↔

- 3** (SLV-E730EX only)
Push the joystick to **↑/↓/←/→** to move the cursor (▶) to NORMAL/CATV, then select NORM.



↑ TUNER	PROG10
▶ NORMAL / CATV	[NORM]
CHANNEL SET	[C21]
AFT FINE TUNING	[ON]
SELECT	: ↔
SET	: ↔

To preset CATV (Cable Television) channels, select CATV.

continued

Manual setup — Presetting channels (continued)

4



Push the joystick to \uparrow/\downarrow to move the cursor (\blacktriangleright) to CHANNEL SET.

TUNER	PROG10
NORMAL / CATV	[NORM]
\blacktriangleright CHANNEL SET	[C21]
AFT FINE TUNING	[ON]
SELECT	: $\blacktriangleleft\blacktriangleright$
SET	: $\blacktriangleleft\blacktriangleright$

5



Press PROG +/- to select the programme position.

Selected programme position

TUNER	PROG4
NORMAL / CATV	[NORM]
\blacktriangleright CHANNEL SET	[C21]
AFT FINE TUNING	[ON]
SELECT	: $\blacktriangleleft\blacktriangleright$
SET	: $\blacktriangleleft\blacktriangleright$

6



Push the joystick to $\blacktriangleleft/\blacktriangleright$ repeatedly until the channel you want is displayed.

The channels appear in the following order:

- VHF IA - IJ, SA10 - SA13 (SLV-E730EX only)
- UHF B21 - B69
- CATV S1 - S20 (SLV-E730EX only)
- HYPER S21 - S41 (SLV-E730EX only)
- CATV S01 - S05 (SLV-E730EX only)

If you know the number of the channel you want, press the programme number buttons. For example, for channel 43, first press "4" and then press "3."

TUNER	PROG 4
NORMAL / CATV	[NORM]
\blacktriangleright CHANNEL SET	[C56]
AFT FINE TUNING	CH4 [ON]
SELECT	: $\blacktriangleleft\blacktriangleright$
SET	: $\blacktriangleleft\blacktriangleright$

7

To allocate another channel to another programme position, repeat steps 5 and 6.

8



Press the joystick (OK).

Disabling unwanted programme positions

After presetting channels, you can disable unused programme positions. The disabled positions will be skipped later when you press the PROG +/- buttons.

- 1 In step 6 above, press programme number button "0" twice to display the number "00" beside CHANNEL SET.
- 2 Press the joystick (OK).

If the picture is not clear

Normally, the Auto Fine Tuning (AFT) function automatically tunes in channels clearly. If, however, the picture is not clear, you may also use the manual tuning function.

- 1 Press PROG +/- or the programme number buttons to select the programme number for which you cannot obtain a clear picture.
- 2 Press MENU, then select SETTINGS and press the joystick (OK).
- 3 Select TUNER, then press the joystick (OK).
- 4 Select FINE TUNING.

The fine tuning meter appears.

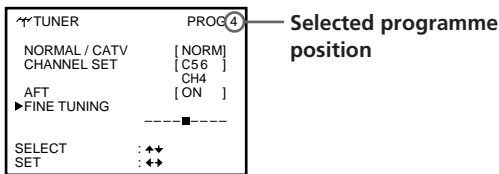

- 5 Push the joystick to ←/→ to get a clearer picture, then press the joystick (OK).

Note that the AFT (Auto Fine Tuning) setting switches to OFF.

Note

- The menu disappears automatically if you don't proceed for more than a few minutes.

Manual setup — Setting up VIDEO Plus+

VIDEO Plus+ is a feature that simplifies programming the VCR to make timer recordings. To use VIDEO Plus+, each programme position needs to be matched with its VIDEO Plus+ guide channel. If the guide channels were not preset in the Auto Set Up procedure, you need to set them manually. To get the guide channel numbers, see “Guide channels for VIDEO Plus+” on page 20, or look in the programme guide for your area that features PlusCode.

- If you want to record satellite broadcasts using VIDEO Plus+, see page 21.

Before you start...

- Turn on the VCR and the TV.
- Set the TV to the video channel.

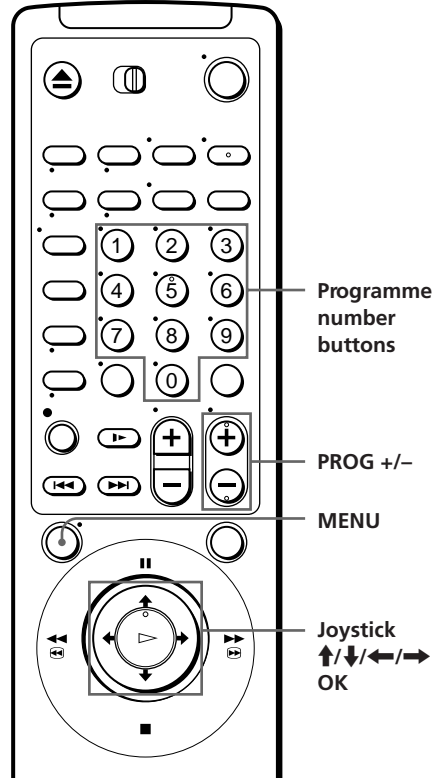

- 1**  **MENU** Press MENU, then push the joystick to **↑/↓** to select SETTINGS and press the joystick (OK).



SETTINGS	
▶	OPTIONS
▶	TUNER
▶	VIDEO PLUS+
○	CLOCK
▶	LANGUAGE
SELECT	: ↑/↓
SET	: OK

- 2**  Push the joystick to **↑/↓** to select VIDEO PLUS+, then press the joystick (OK).



The preset channels are displayed on the screen. “---” in the GUIDE CH column means that the guide channel has not been preset.

VIDEO PLUS+		
PROG	CH	GUIDE CH
▶ BBC1	C42	[1]
BBC2	C25	2
ITV	C27	3
CH4	C56	4
5	C36	---
SELECT	: ↑/↓	
SET	: 0 - 9	
CANCEL	: CLEAR	

3



Push the joystick to \uparrow/\downarrow to move the cursor (\blacktriangleright) to the row on which you want to set the guide channel.

To display other pages for programme positions 6 to 60, push the joystick to \uparrow/\downarrow repeatedly.

VIDEO PLUS+			
PROG	CH	GUIDE	CH
BBC1	C42		1
BBC2	C25		2
ITV	C27		3
CH4	C56		4
\blacktriangleright 5	C36		[---]
SELECT		:	$\uparrow\downarrow$
SET		:	0-9
CANCEL		:	CLEAR

4

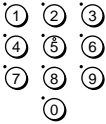

Press the programme number buttons to enter the guide channel number assigned in the programme guide.

VIDEO PLUS+			
PROG	CH	GUIDE	CH
BBC1	C42		1
BBC2	C25		2
ITV	C27		3
CH4	C56		4
\blacktriangleright 5	C36		[129]
SELECT		:	$\uparrow\downarrow$
SET		:	0-9
CANCEL		:	CLEAR

5

To set the guide channel of another station, repeat steps 3 to 4.

6



Press the joystick (OK).

continued

Manual setup — Setting up VIDEO Plus+ (continued)

Guide channels for VIDEO Plus+

Guide channel	Station name	Guide channel	Station name
001	BBC1	125	BRAVO
002	BBC2		HSND
003	ITV		EBN
004	CHANNEL 4	126	CNN
005	CHANNEL 5	127	EURONEWS
006	RTE 1	128	PERFORMANCE
007	RTE 2		THE ARTS CHANNEL
008	TV NA GAELTACHTA	129	SKY MOVIES GOLD
101	SKY ONE		WEATHER
102	SKY NEWS	130	UK LIVING
103	SKY MOVIES		TELEVISION X FANTASY
104	THE MOVIE CHANNEL		CHANNEL
105	SKY SPORT	131	GRANADA +
106	NICKELODEON	132	GRANADA TALK
	PARAMOUNT CHANNEL		SKY SCOTTISH
107	EUROSPORT	133	TV5 EUROPE
	QUANTUM TV	134	TVE INTERNATIONAL
108	WARNER BROTHERS	135	MBC
109	MTV EUROPE		ARABIC
110	CHILDREN'S CHANNEL	136	QVC
	THE FAMILY CHANNEL	137	SPORTNET
111	THE DISNEY CHANNEL	138	COUNTRY MUSIC TV
112	BBC WORLD SERVICE		JAPANESE TV
113	RTL 4	140	SKY SPORT 2 & SOAPS &
114	FILMNET 2		TRAVEL & HIST & SF
	SUPER SPORT	141	TV ASIA
	ADULT CHAN	142	GRANADA GOOD LIFE
115	RTL PLUS INTERNATIONAL		GRANADA TV HIGH STREET
116	SAT 1		GRANADA FOOD + WINE
117	PREMIERE		GRANADA HEALTH AND
118	3 SAT		BEAUTY
119	SKY 2		GRANADA HOME + GARDEN
	FOX KIDS	143	LIVE TV
120	PRO 7	144	SUPERCHANNEL
121	TELE 5	145	VIDEO HITS ONE
122	TELECLUB		VH-1 (ENGLISH)
123	UK GOLD	146	SELECT TV
124	TLC	147	FILMNET 1 (24 HOUR)
	DISCOVERY	148	SKY SPORT 3
	REGAL SHOP		PLAYBOY TV
		149	TNT
			CARTOON NETWORK

Note

- The guide channel codes listed above are as of 20 February 1997. If you have any questions about the guide channels, please consult your nearest Sony service facility or the marketing group of Sony UK.

Setting up VIDEO Plus+ for satellite broadcasts

When your satellite tuner is connected via the AERIAL IN connector, first you have to set the programme position for each satellite channel using the TUNER menu. Then set the guide channel number for each satellite channel using the VIDEO PLUS+ menu.

If your satellite tuner is connected via the LINE-1 (TV) connector, you don't have to set programme positions nor guide channel numbers for satellite channels. Skip the following procedure.

- 1 Turn on the satellite tuner.
- 2 Press MENU, then select SETTINGS and press the joystick (OK).
- 3 Select TUNER, then press the joystick (OK).
- 4 Press PROG +/- to select a programme position you want to use for watching a satellite channel.
- 5 Select CHANNEL SET, then push the joystick to \leftarrow/\rightarrow repeatedly to tune the VCR to the satellite tuner.

The channel number displayed beside CHANNEL SET is used for receiving all satellite broadcasts from the satellite tuner.

Remember this number for the following steps.

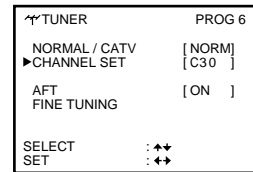

- 6 Press PROG +/- to select another programme position for the next satellite channel, and press the programme number buttons to enter the same channel number as the one displayed in step 5. Otherwise, the setting will not be memorized.
Repeat this step for all satellite channels, then press the joystick (OK).
- 7 Set the guide channel number for each programme position assigned to the satellite channel, following the procedures on page 18.

Notes

- The menu disappears automatically if you don't proceed for more than a few minutes.
- If you use a satellite tuner connected via the LINE-1 (TV) connector, you don't have to set up VIDEO Plus+. Just record a satellite programme using VIDEO Plus+, and the VCR automatically records the programme from the LINE-1 (TV) connector.
- If you inadvertently entered a guide channel number, press CLEAR.
- The VCR does not allow entering the guide channel number if the same number has been set.
- When you record a satellite broadcast using VIDEO Plus+, you need to select the desired channel on the satellite tuner manually.

Manual setup — Setting the clock

You must set the time and date on the VCR to use the timer recording features properly. If the VCR clock was not set in the Auto Set Up procedure, you need to set it manually.

The Auto Clock Set function works only if a station in your area is broadcasting a time signal. If the Auto Set Up did not set the clock correctly for your local area, try another station for the Auto Clock Set function.

Before you start...

- Turn on the VCR and the TV.
- Set the TV to the video channel.

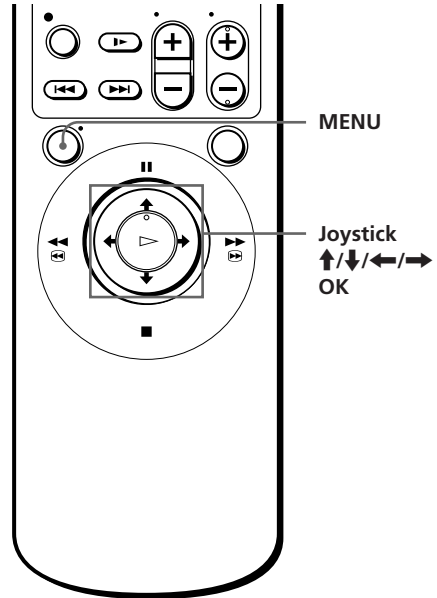

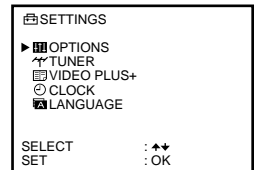

Setting the clock manually

- 1**  **MENU** Press MENU, then push the joystick to **↑/↓** to select SETTINGS and press the joystick (OK).

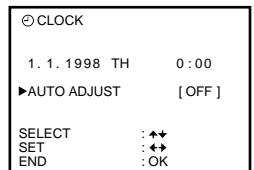

- 2**  Push the joystick to **↑/↓** to select CLOCK, then press the joystick (OK).



- 3**  Push the joystick to **↑/↓** to move the cursor (▶) to the clock row, then push the joystick to **→**.
The day starts flashing.

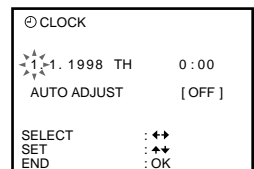

4



Push the joystick to \uparrow/\downarrow to set the date.

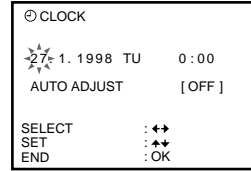

5



Push the joystick to \rightarrow to flash the month and set the month pushing the joystick to \uparrow/\downarrow .

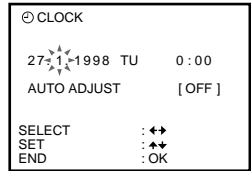

6



Set the year, hour, and minutes in sequence, pushing the joystick to \rightarrow to flash the item to be set, and push the joystick to \uparrow/\downarrow to select the digits. The day of the week is set automatically.

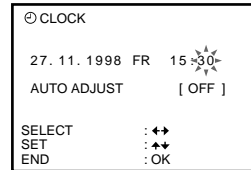

7



Push the joystick to \rightarrow to start the clock. The cursor (\blacktriangleright) appears at the beginning of the line.

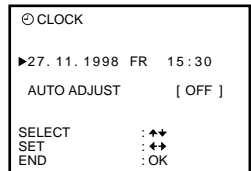

8



Press the joystick (OK).

Tip

- To change the digits during setting, push the joystick to \leftarrow to return to the item to be changed, and select the digits pushing the joystick to \uparrow/\downarrow .

Note

- The menu disappears automatically if you don't proceed for more than a few minutes.

continued

Manual setup — Setting the clock (continued)

Changing the station for the Auto Clock Set function

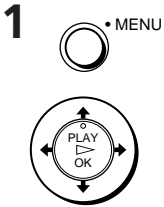
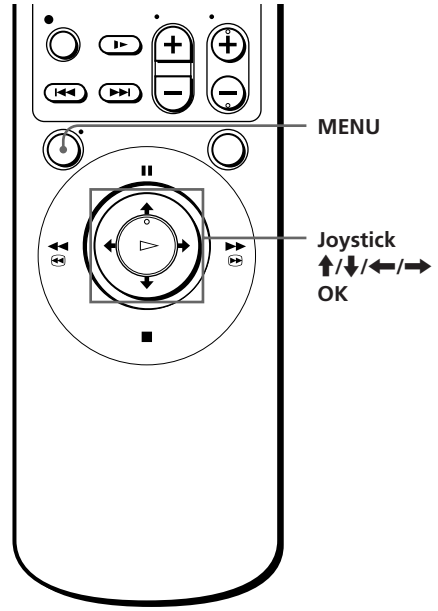

Press MENU, then push the joystick to **↑/↓** to select SETTINGS and press the joystick (OK).

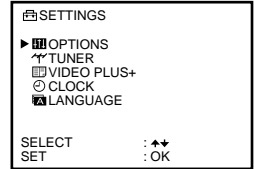

Push the joystick to **↑/↓** to select CLOCK, then press the joystick (OK).
The cursor (▶) appears at AUTO ADJUST.

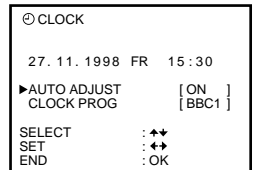

3



Push the joystick to ←/→ to select ON.

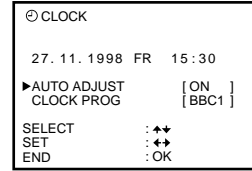

4



Push the joystick to ↓ to move the cursor (▶) to CLOCK PROG, then push the joystick to ←/→ repeatedly until the programme position of a station that carries the time signal appears.

If the VCR does not receive the time signal from any station, AUTO ADJUST returns to OFF automatically.

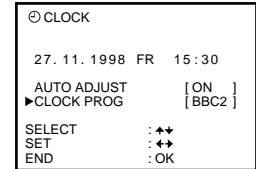

5



Press the joystick (OK).

Tip

- If you set AUTO ADJUST to ON, the Auto Clock Set function is activated whenever the VCR is turned off. The date and time is adjusted automatically by making reference to the time signal from the station whose programme position is displayed in the "CLOCK PROG" row.
If you do not need the Auto Clock Set, select OFF.

Note

- The menu disappears automatically if you don't proceed for more than a few minutes.

Setting your personal code

For identification, you can enter a personal code into the VCR. Once you enter your personal code, you can confirm it any time but can never change it.

Before you start...

- Turn on your TV and set the TV to the video channel.
- If there is a tape in the VCR, remove it.
- Turn off the VCR.

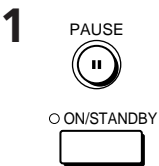
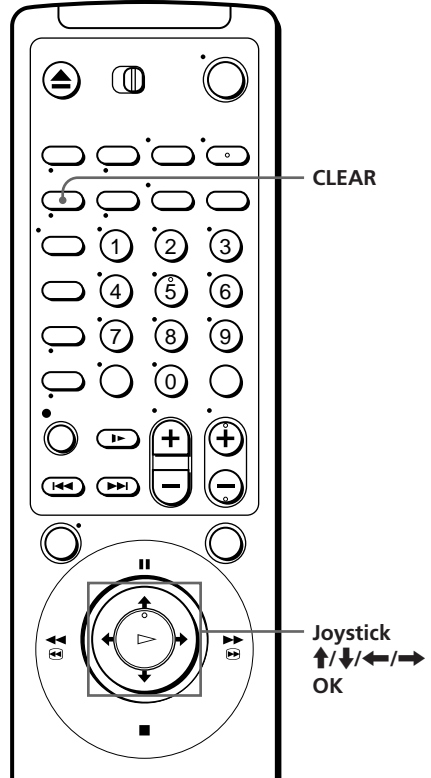
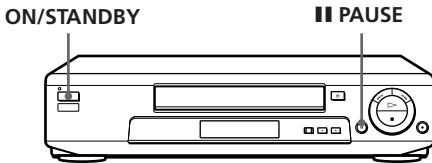

Hold down **PAUSE** and **ON/STANDBY** on the VCR simultaneously for more than three seconds.

SECURITY FUNCTION	
PERSONAL CODE	
☼-----1	
SELECT	: ↔
SET	: ↔
CONFIRM	: OK

2



Enter your personal code.

1 Push the joystick to \uparrow/\downarrow to select a character.

Each time you push the joystick to \uparrow , the character changes as shown below.

A \rightarrow B \rightarrow ... \rightarrow Z \rightarrow 0 \rightarrow 1 \rightarrow ... \rightarrow 9
 \rightarrow (blank space) \rightarrow - (hyphen) \rightarrow A

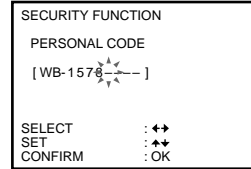

2 Push the joystick to \rightarrow to set the next character.

The next space flashes.

To correct a character, push the joystick to \leftarrow/\rightarrow until the character you want to correct flashes, then reset it.

You can set up to 11 characters for your personal code.

3



Press the joystick (OK).

A confirmation screen appears.

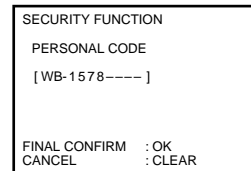

4



If the displayed personal code is correct, press the joystick (OK).

If the displayed personal code is wrong, press CLEAR and continue from step 2.

CLEAR



To confirm your personal code

While the VCR is turned off and there is no tape in the VCR, hold down **|| PAUSE** and **ON/STANDBY** on the VCR simultaneously for more than three seconds. The entered personal code appears on the TV screen. Press any button to enter normal viewing mode.

Note

- The menu disappears automatically if you don't proceed for more than a few minutes.

Playing a tape

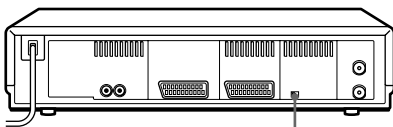
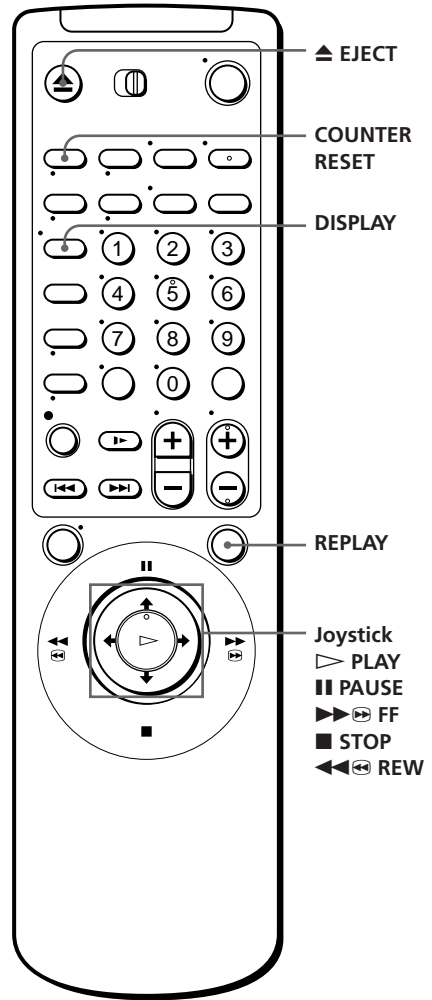

NTSC PB

1 Turn on your TV and set it to the video channel.

2 Insert a tape.
The VCR turns on and starts playing automatically if you insert a tape with its safety tab removed.

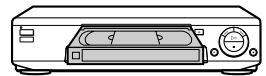

3

Press the joystick (▷ PLAY).

When the tape reaches the end, it will rewind automatically.

Additional tasks

To	Push the joystick to
Stop play	■ STOP
Pause play	PAUSE
Resume play after pause	PAUSE or press the joystick (▷ PLAY)
Fast-forward the tape	▶▶ FF during stop
Rewind the tape	◀◀ REW during stop
Eject the tape	Press ▲ EJECT.

To replay a recently watched scene

You can immediately rewind and playback the scene you want to watch again.

During playback, press REPLAY up to four times. The VCR rewinds the tape about 10 seconds on the counter for each press of the button, and restarts playback.

To play an NTSC-recorded tape

Set NTSC PB at the rear of the VCR according to the colour system of your TV.

When your TV is	Set NTSC PB to
PAL only	ON PAL TV
PAL and NTSC	NTSC 4.43

continued

Playing a tape (continued)

To use the time counter

At the point on the tape that you want to find later, press COUNTER RESET. The counter in the display window resets to "0:00:00." Search for the point afterwards by referring to the counter.



To display the counter on the TV screen, press DISPLAY.

Notes

- The counter resets to "0:00:00" whenever a tape is reinserted.
- The counter stops counting when it comes to a portion with no recording.
- The time counter does not appear on the TV screen when using an NTSC-recorded tape.
- Depending on your TV, the following may occur while playing an NTSC-recorded tape:
 - The picture becomes black and white.
 - The picture shakes.
 - No picture appears on the TV screen.
 - Black streaks appear horizontally on the TV screen.
 - The colour density increases or decreases.
- If you play back a tape in LP or EP mode with NTSC system, the sound is heard in monaural.
- While setting the menu on the TV screen, you cannot use the joystick for tape operation.

Recording TV programmes

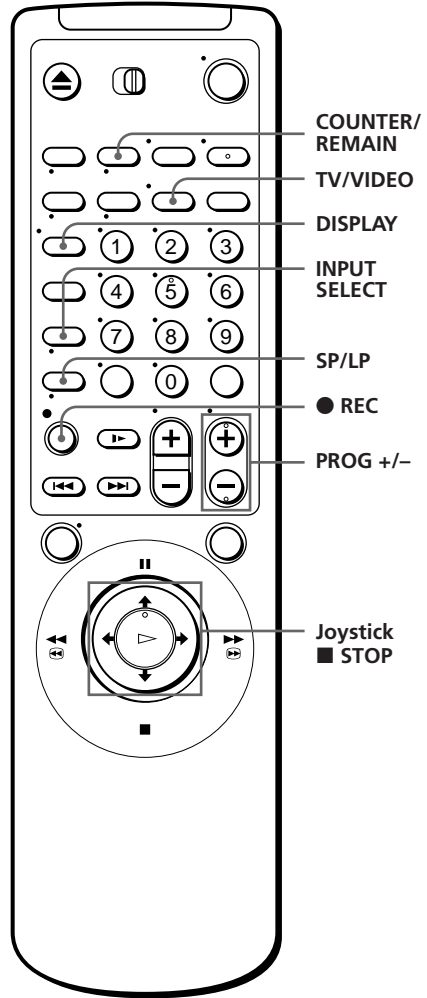

- 1** Turn on your TV and set it to the video channel.
- 2** Insert a tape with its safety tab in place.

continued

Recording TV programmes (continued)

3



Press INPUT SELECT until a programme position number appears in the display window.



4



Press PROG +/- to select the programme position you want to record.



5



Press SP/LP to select the tape speed, SP or LP.

LP (Long Play) provides recording time twice as long as SP, however, SP (Standard Play) produces better picture and audio quality.



6



Press ● REC to start recording.

The recording indicator lights up red in the display window.

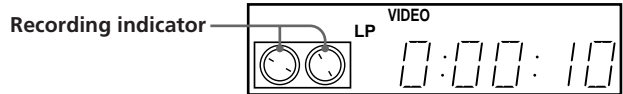

To stop recording

Push the joystick to ■ STOP.

To check the remaining time

Press DISPLAY. With the display on, press COUNTER/REMAIN to check the remaining time. Each time you press COUNTER/REMAIN, the time counter and the remaining time appear alternately. The remaining time with the  indicator also appears in the display window.

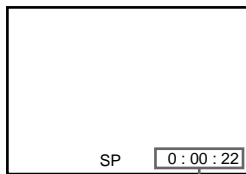

Time counter

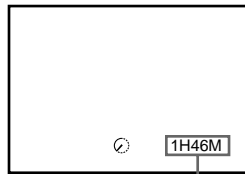

Remaining time

To correctly check the remaining time of the tape, set TAPE SELECT in the TAPE OPTIONS menu according to the tape type you use (see page 51).

To watch another TV programme while recording

- 1 Press TV/VIDEO to turn off the VIDEO indicator in the display window.
- 2 Select another programme position on the TV.

To save a recording

To prevent accidental erasure, break off the safety tab as illustrated. To record on a tape again, cover the tab hole with adhesive tape.

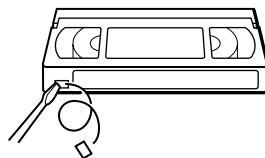

Safety tab

continued

Recording TV programmes (continued)

Tips

- To select a programme position, you can use the programme number buttons on the remote commander. For two-digit numbers, press the -- (ten's digit) button followed by the programme number buttons.
- You can select a video source from the LINE-1 (TV) or LINE-2 IN (Scart) connector using the INPUT SELECT button.
- The display appears on the TV screen indicating information about the tape, but the information won't be recorded on the tape.
- If you don't want to watch TV while recording, you can turn off the TV.

Notes

- The display does not appear during still (pause) mode or slow-motion playback.
- The display will not appear while playing an NTSC-recorded tape.
- If a tape has portions recorded in both PAL and NTSC systems, the time counter reading will not be correct. This discrepancy is due to the difference between the counting cycles of the two video systems.
- When you insert a non-standard commercially available tape, the remaining time may not be correct.
- The remaining time doesn't work for an NTSC-recorded tape. “-H- -M” appears in the display window.
- The remaining time is intended for rough measurement only.
- About 30 seconds after the tape begins playback, the tape remaining time will be displayed.

Recording TV programmes using VIDEO Plus+

Just enter the programme's PlusCode listed in the TV programme guide. The date, times, and programme position of that programme are set automatically. You can preset up to eight programmes at a time.

Before you start...

- Check that the VCR clock is set to the correct time.
- Insert a tape with its safety tab in place. Make sure the tape is longer than the total recording time.
- Turn on your TV and set it to the video channel.

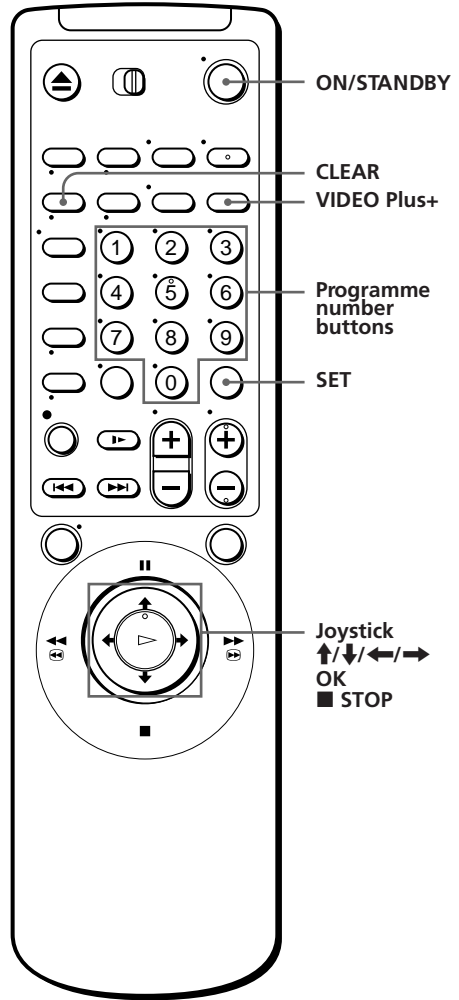

1 VIDEO Plus+



Press VIDEO Plus+.

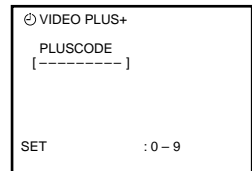

continued

Recording TV programmes using VIDEO Plus+ (continued)

2

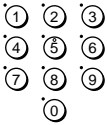

Press the programme number buttons to enter the programme's PlusCode, then press SET.

If you make a mistake before pressing SET, press VIDEO Plus+ and re-enter the correct number.

The date, start and stop times, and programme position (or the station name if it is detected) appear on the TV screen.

If the information is incorrect, press CLEAR to cancel the setting.

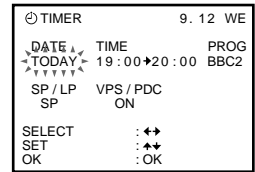

3



If you want to change the date, tape speed, and the VPS/PDC function setting:

1 Push the joystick to ←/→ to flash the item you want to change.

2 Push the joystick to ↑/↓ to reset it.

- To record the same programme every day or the same day every week, see "Daily/weekly recording" on page 37.

- To use the VPS/PDC function, set VPS/PDC to ON.

For details of the VPS/PDC function, see "Timer recording with VPS/PDC signals" on page 37.

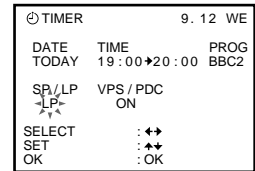

4



Press the joystick (OK) to complete the setting.

5

ON/
STANDBY



Press ON/STANDBY to turn off the VCR.

The Ⓞ indicator appears in the display window and the VCR stands by for recording.

To stop recording

To stop the VCR while recording, push the joystick to ■ STOP.

Daily/weekly recording

In step 3 above, push the joystick to ↓ to select the recording pattern. Each time you push the joystick to ↓, the indication changes as shown below. Push the joystick to ↑ to change the indication in reverse order.

TODAY → **SU-SA (Sunday to Saturday)** → **MO-SA (Monday to Saturday)**
 → **MO-FR (Monday to Friday)** → **SA (every Saturday)**
 → **MO (every Monday)** → **SU (every Sunday)** → **1 month later**
 → **(dates count down)** → **TODAY**

Timer recording with VPS/PDC signals

Some broadcast systems transmit VPS (Video Programme System) or PDC (Programme Delivery Control) signals with their TV programmes. These signals ensure that your timer recordings are made regardless of broadcast delay, early starts or broadcast interruptions.

To use the VPS/PDC function, set VPS/PDC to ON. You can also use the VPS/PDC function for a source connected to the LINE-1 (TV) and LINE-2 IN (Scart) connectors.

To record satellite broadcasts

If you connect the satellite tuner and the VCR, you can record satellite programmes.

- 1** Turn on the satellite tuner.
- 2** On the satellite tuner, select the satellite programme for which you want to make a timer setting.
- 3** Keep the satellite tuner turned on until the VCR finishes recording the satellite programme for which you have made a timer setting.

To use the VCR after setting the timer

To use the VCR before a timer recording begins, just press ON/STANDBY. The ⊕ indicator turns off and the VCR switches on. Remember to press ON/STANDBY to reset the VCR after using the VCR.

You can also do the following tasks while the VCR is recording:

- Reset the counter.
- Display tape information on the TV screen.
- Check the timer settings.
- Watch another TV programme.

Tips

- To set the tape speed, you can also use the SP/LP button.
- When you are recording a programme in the SP mode and the remaining tape becomes shorter than the recording time, the tape speed is automatically changed to the LP mode. Note that some interference will appear on the picture at the point the tape speed is changed. If you want to keep the same tape speed, set AUTO TAPE SPEED to OFF in the TAPE OPTIONS menu (page 51).

Setting the timer manually

If VIDEO Plus+ is not available in your area, follow the instructions below to set the timer to record programmes.

Before you start...

- Check that the VCR clock is set to the correct time.
- Insert a tape with its safety tab in place. Make sure the tape is longer than the total recording time.
- Turn on your TV and set it to the video channel.

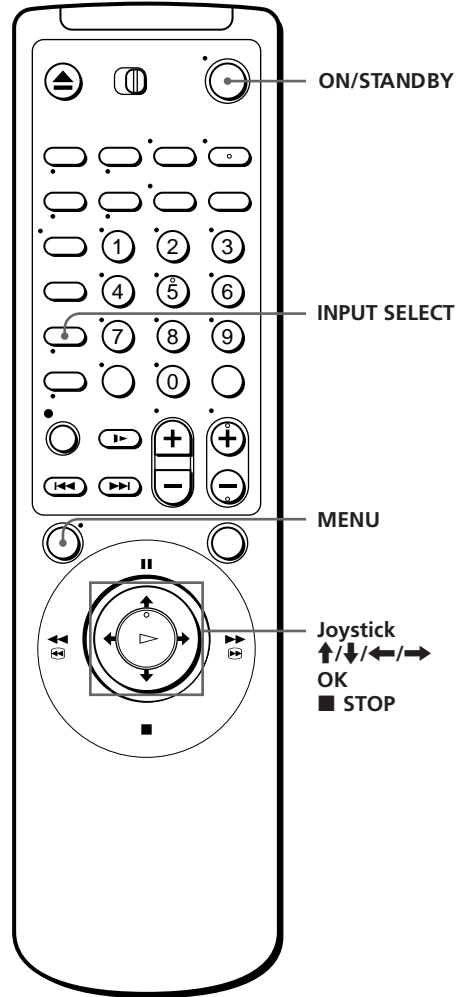

1

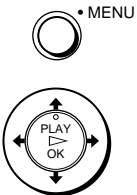

Press MENU and select TIMER, then press the joystick (OK).

⊙ TIMER	9. 12 WE	
DATE	TIME	PROG
↑ TODAY ↓	- : - - -	- : - -
↑ ↑ ↑ ↑ ↑		
SP / LP	VPS / PDC	
SP	ON	
SELECT	: ↔	
SET	: ↕	
OK	: OK	

2



Set the date, start and stop times, programme position, tape speed, and VPS/PDC function:

- 1 Push the joystick to \rightarrow to flash each item in turn.
- 2 Push the joystick to \uparrow/\downarrow to set each item.

To correct a setting, push the joystick to \leftarrow to return to that setting and reset.

- To record the same programme every day or the same day every week, see "Daily/weekly recording" on page 40.
- To use the VPS/PDC function, set VPS/PDC to ON. For details of the VPS/PDC function, see "Timer recording with VPS/PDC signals" on page 37.
- To record from another source connected to the LINE-1 (TV) or LINE-2 IN (Scart) connector, press INPUT SELECT to display "L1" or "L2" in the "PROG" position.



⊙ TIMER		9. 12 WE
DATE TODAY	TIME 19:00	PROG BBC2
SP / LP	VPS / PDC	
LP	-ON-	
SELECT	: \leftrightarrow	
SET	: \leftrightarrow	
OK	: OK	

3



Press the joystick (OK) to complete the setting.

4

• ON/
STANDBY



Press ON/STANDBY to turn off the VCR.

The \odot indicator appears in the display window and the VCR stands by for recording.

To record from another source, leave the connected equipment switched on.

To stop recording

To stop the VCR while recording, push the joystick to \blacksquare STOP.

continued

Setting the timer manually (continued)

Daily/weekly recording

In step 2 above, push the joystick to ↓ to select the recording pattern. Each time you push the joystick to ↓, the indication changes as shown below. Push the joystick to ↑ to change the indication in reverse order.

TODAY → **SU-SA (Sunday to Saturday)** → **MO-SA (Monday to Saturday)**
→ **MO-FR (Monday to Friday)** → **SA (every Saturday)**
→ **MO (every Monday)** → **SU (every Sunday)** → **1 month later**
→ **(dates count down)** → **TODAY**

Tips

- To set the programme position, you can also use the PROG +/- or programme number buttons.
- To set the tape speed, you can also use the SP/LP button.
- When you are recording a programme in the SP mode and the remaining tape becomes shorter than the recording time, the tape speed is automatically changed to the LP mode. Note that some interference will appear on the picture at the point the tape speed is changed. If you want to keep the same tape speed, set AUTO TAPE SPEED to OFF in the TAPE OPTIONS menu (page 51).

Notes

- When setting the timer with VPS/PDC signals, enter the start and stop times exactly as indicated in the TV programme guide, otherwise the VPS/PDC function won't work.
- If the VPS/PDC signal is too weak or the broadcasting station failed to transmit VPS/PDC signals, the VCR will start recording at the set time without using the VPS/PDC function.
- The Ⓞ indicator flashes in the display window when you press ON/STANDBY with no tape inserted.

Playing/searching at various speeds

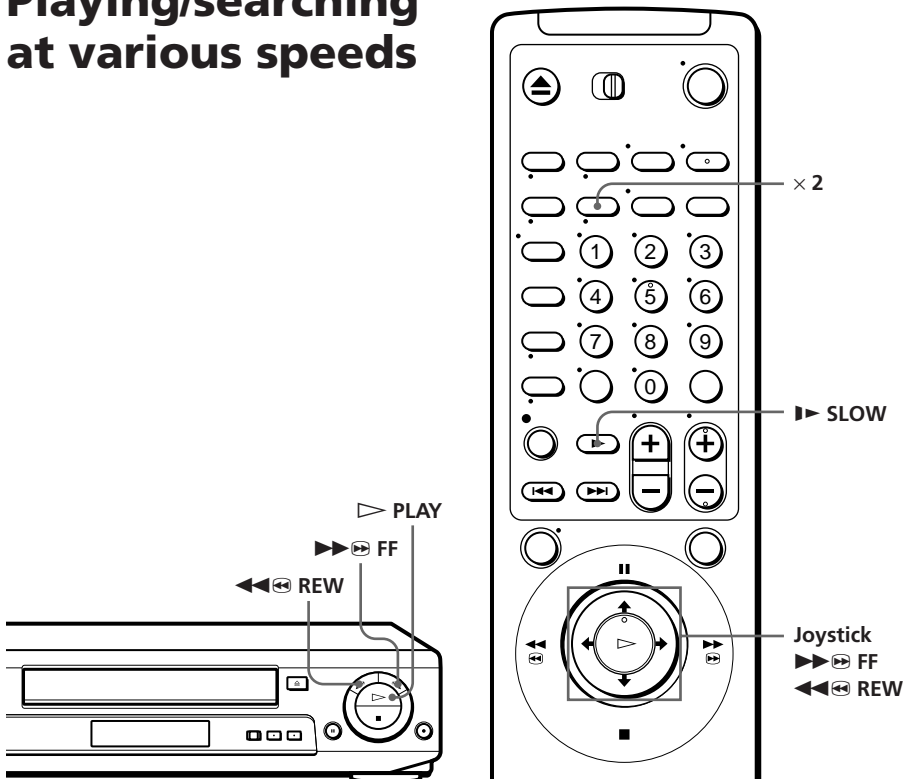

Playback options	Operation
View the picture during fast-forward or rewind	During fast-forward, keep pushing the joystick to ►►► FF. During rewind, keep pushing the joystick to ◀◀◀ REW.
Play at high speed	<ul style="list-style-type: none"> • During playback, push the joystick to ►►► FF or ◀◀◀ REW. • During playback, keep pushing the joystick to ►►► FF or ◀◀◀ REW. When you release the joystick, normal playback resumes.
Play at twice the normal speed	During playback, press × 2.
Play in slow motion	During playback, press ►► SLOW.
Play frame by frame	During pause, push the joystick to ►►► FF or ◀◀◀ REW. Keep pushing the joystick to ►►► FF or ◀◀◀ REW to play one frame each second.
Rewind and start play	During stop, press ►► PLAY on the VCR while holding ◀◀◀ REW down on the VCR.

continued

Playing/searching at various speeds (continued)

To resume normal playback

Press the joystick (▷ PLAY).

Tip

- Adjust the picture using the TRACKING +/- buttons if:
 - Streaks appear while playing in slow motion.
 - Bands appear at the top or bottom while pausing.
 - The picture shakes while pausing.
- To set tracking to the centre position, press both buttons (+/-) at the same time.

Notes

- The playback sound is muted during the operations in the above table.
- In the LP mode, noise may appear or there may be no colour.
- If the playback mode mark doesn't appear on the TV screen, press DISPLAY.

Recording TV programmes using the quick timer

After starting recording in the normal way, you can have the VCR stop recording automatically after a specified duration.

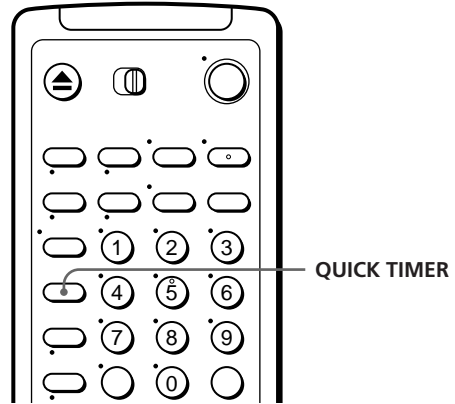

- 1 While recording, press QUICK TIMER once.
The ⏸ indicator appears in the display window.

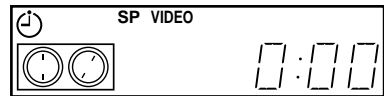

- 2 Press QUICK TIMER repeatedly to set the duration.
Each press advances the time in increments of 30 minutes.

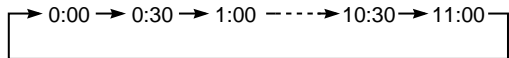

The duration decreases minute by minute to 0:00, then the VCR stops recording and turns off automatically.

To extend the duration

Press QUICK TIMER repeatedly to set to the new duration.

To stop recording

To stop the VCR while recording, push the joystick to ■ STOP.

Using the quick timer during stop mode

You can set the quick timer and start recording during stop mode by pressing QUICK TIMER. To set the programme position, you can use the PROG +/- or INPUT SELECT buttons. Press QUICK TIMER repeatedly to set the recording duration. The recording will start automatically.

Checking/ changing/ cancelling timer settings

Before you start...

- Turn on your TV and set it to the video channel.

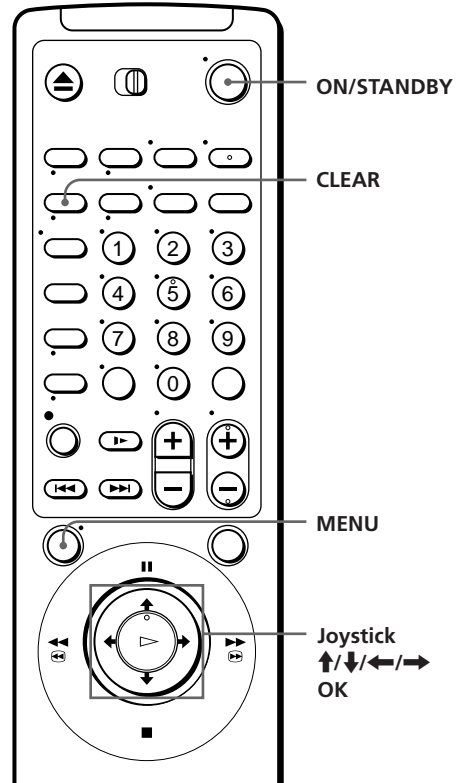

- 1 Press ON/STANDBY to turn on the VCR.
- 2 Press MENU and select LIST, then press the joystick (OK):
 - If you want to change or cancel a setting, go on to the next step.
 - If you do not need to change or cancel the settings, press the joystick (OK), then turn off the VCR to return to recording standby.

LIST	DATE	TIME	PROG	9. 12 WE
▶	9. 12	1900+2000	BBC2 LP	REC
	28. 12	0930+1000	CH4 SP	REC
	17. 12	0500+0530	BBC1 LP	REC
	MO-FR	0000+0100	L1 LP	REC
	MO-SA	2300+0000	L2 SP	REC
	SU-SA	1212+2000	ITV LP	REC
	-- --	---->----	-- --	-- --

- 3** Push the joystick to **↑/↓** to select the setting you want to change or cancel, then press the joystick (OK).

The selected setting appears in the TIMER menu.

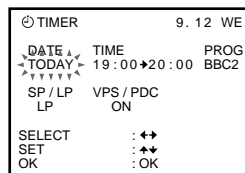

- 4**
- To change the setting, push the joystick to **←/→** to flash the item you want to change, and push the joystick to **↑/↓** to reset it.
 - To cancel the setting, press CLEAR.

- 5** Press the joystick (OK).

If any settings remain, turn off the VCR to return to recording standby.

When the timer settings overlap

The programme that starts first has priority and the second programme starts recording only after the first programme has finished. If the programmes start at the same time, the programme listed first in the menu has priority.

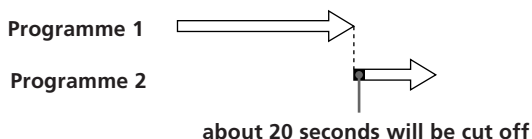
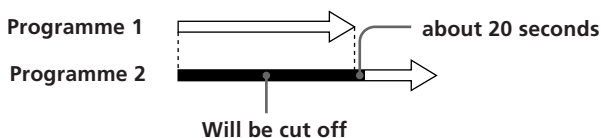

Recording stereo and bilingual programmes

In NICAM system

This VCR receives and records stereo and bilingual programmes based on the NICAM system (the NICAM indicator appears). When a stereo or bilingual programme is received, the STEREO indicator appears in the display window.

To record a NICAM programme, HI-FI AUDIO in the OPTIONS menu should be set to NICAM (initial setting). To check the menu setting, see page 52 for details.

To select the sound while recording

Press AUDIO MONITOR to select the sound you want.

Stereo programme

To listen to	On-screen display	Display window
Stereo	STEREO	STEREO
Standard sound*	No indicator	No indicator

* Usually the mixed sound of left and right channels (monaural)

Bilingual programme

To listen to	On-screen display	Display window
Main	MAIN	STEREO
Sub	SUB	STEREO
Main and sub	MAIN/SUB	STEREO
Standard sound*	No indicator	No indicator

* Usually the main sound (monaural)

Selecting the sound during playback

Press AUDIO MONITOR to select the sound you want.

To listen to	On-screen display	Display window
Stereo/main and sub (left and right channels)	STEREO	STEREO
Left channel/main	L	STEREO
Right channel/sub	R	STEREO
Standard sound	No indicator	No indicator

How sound is recorded on a video tape

The VCR records sound onto two separate tracks. Hi-fi audio is recorded onto the main track along with the picture. Monaural sound is recorded onto the normal audio track along the edge of the tape.

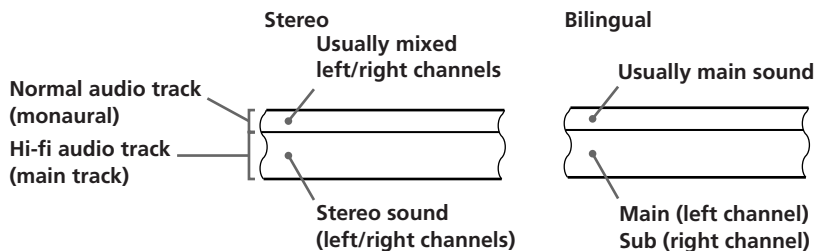

Notes

- To listen to playback sounds in stereo, you must use the EURO-AV or AUDIO OUT connections.
- When you play a tape recorded in monaural, the sound is heard in monaural regardless of the AUDIO MONITOR setting.
- If the AUDIO MONITOR button does not function, check that AUDIO MIX in the OPTIONS menu is set to OFF (see page 52).
- If HIFI AUDIO is set to STD, the standard sound will be recorded on both the hi-fi and normal audio tracks. Pressing AUDIO MONITOR will not change the sound.

Searching using the index function

The VCR marks the tape with an index signal at the point where each recording begins. Use these signals as references to find a specific recording.

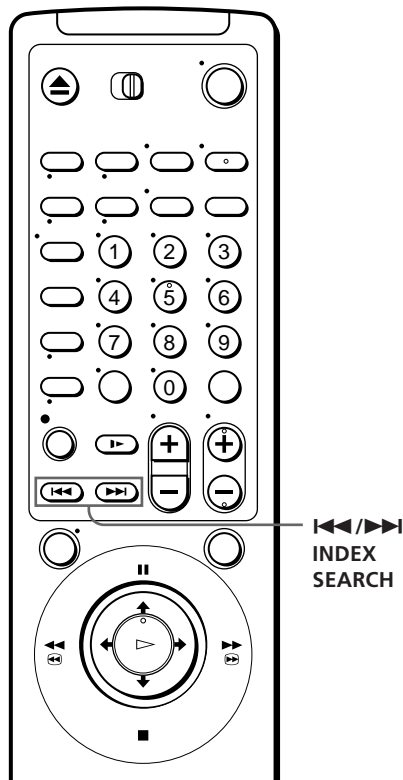

- 1 Insert an indexed tape into the VCR.
- 2 Press **◀◀ / ▶▶** INDEX SEARCH.
 - To search ahead, press **▶▶** INDEX SEARCH.
 - To search backwards, press **◀◀** INDEX SEARCH.

The VCR starts searching, and playback starts automatically from that point.

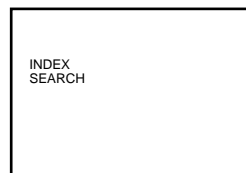

To stop searching

Push the joystick to **■** STOP.

Note

- No index signal will be added when recording starts from recording pause. However, an index signal will be marked if you change the programme position during recording pause.

Adjusting the picture

Adjusting the tracking

Although the VCR automatically adjusts the tracking when playing a tape (the  indicator flashes in the display window, then goes off), distortion may occur if the tape was recorded in poor condition. In this case, manually adjust the tracking.

During playback, press TRACKING +/- on the VCR to display the tracking meter. The distortion should disappear as you press one of the two buttons (the  indicator lights up). To resume automatic tracking adjustments, eject the tape and reinsert it.

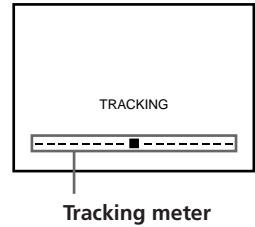

About Optimum Picture Control (OPC)

Optimum Picture Control (OPC) automatically improves recording and playback quality by adjusting the VCR to the condition of the video heads and tape. To maintain better picture quality, we recommend that you set OPC to ON in the VIDEO OPTIONS menu (with the OPC indicator in the display window lit). For details, see page 52.

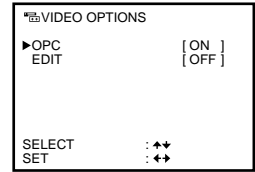

OPC playback

The OPC function automatically works on all types of tapes, including rental tapes and tapes that were not recorded with OPC.

OPC recording

Whenever you insert a tape and start recording for the first time, the VCR adjusts to the tape using the OPC function (the OPC indicator flashes rapidly). This adjustment is retained until the tape is ejected.

To deactivate the OPC

Set OPC to OFF in the VIDEO OPTIONS menu. The OPC indicator in the display window goes off.

continued

Adjusting the picture (continued)

Tip

- To set tracking to the centre position, press the TRACKING + and – buttons at the same time.

Notes

- You can adjust the tracking for the NTSC-recorded tape but the tracking meter won't be displayed.
- With the Auto Tape Speed function on, the OPC function will work only in SP mode. If the tape speed automatically switches from SP to LP, the OPC function turns off. If, however, the entire programme is recorded in LP mode, the OPC function will work.
- There is a delay of a few seconds before the VCR actually starts recording while the VCR analyses the tape. To avoid the delay, first set the VCR to recording pause (the OPC indicator flashes slowly) and press ● REC to have the VCR analyse the tape (the OPC indicator flashes rapidly). After the OPC indicator stops flashing, push the joystick to ■ PAUSE to start recording immediately. If you want to start recording quickly without using the OPC function, first set the VCR to recording pause (the OPC indicator flashes slowly) and push the joystick to ■ PAUSE to start recording.

Changing menu options

- 1 Press MENU, then select SETTINGS.
- 2 Select OPTIONS.

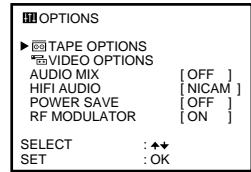

- 3 Push the joystick to **↑/↓** to select the option you want to change:
 - To change the TAPE OPTIONS or VIDEO OPTIONS

- 1 Press the joystick (OK) after selecting TAPE OPTIONS or VIDEO OPTIONS.

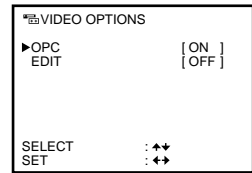
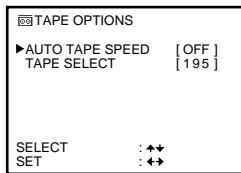

- 2 Push the joystick to **↑/↓** to select the option, then push the joystick to **←/→** to change the setting.

- To change the other options

Push the joystick to **←/→** to change the setting.

- 4 Press the joystick (OK) to return to the original screen.

Menu choices

Initial settings are indicated in bold print.

TAPE OPTIONS menu choices

Menu option	Set this option to
AUTO TAPE SPEED	<ul style="list-style-type: none"> • ON to change the timer recording tape speed automatically to the LP mode when the remaining tape becomes shorter than the recording time. • OFF to keep the set tape speed.
TAPE SELECT	<ul style="list-style-type: none"> • 300 to use an E-300 type tape. • 240 to use an E-240 type tape. • 195 to use an E-195 or shorter type tape.

continued

Changing menu options (continued)

VIDEO OPTIONS menu choices

Menu option	Set this option to
OPC	<ul style="list-style-type: none">• ON to switch on the OPC (Optimum Picture Control) function and improve picture quality.• OFF to switch off OPC.
EDIT	<ul style="list-style-type: none">• ON to minimize picture deterioration when editing.• OFF to turn off EDIT.

Other menu choices

Menu option	Set this option to
AUDIO MIX	<ul style="list-style-type: none">• ON to listen to the hi-fi and normal audio tracks at the same time. The AUDIO MONITOR button will not function.• OFF to listen to the hi-fi and normal audio tracks separately. Select the sound using the AUDIO MONITOR button. <p>For details, see page 47.</p>
HIFI AUDIO	<ul style="list-style-type: none">• STD to record standard sound on the hi-fi audio track.• NICAM to record NICAM broadcasts on the hi-fi audio track. <p>For details, see page 46.</p>
POWER SAVE	<ul style="list-style-type: none">• ON to turn off the indicators in the display window to conserve the VCR power.• OFF to turn on the indicators in the display window while the VCR is standing by.
RF MODULATOR	<ul style="list-style-type: none">• ON if you connect the VCR to your TV using only the aerial cable.• OFF if you connect the VCR to your TV using the EURO-AV cable.

Notes

- When you set a timer recording, the indicators in the display window remain on, even though POWER SAVE is set to ON.
- With the EDIT option ON, the OPC function does not work.

Editing with another VCR

How to connect to record on this VCR

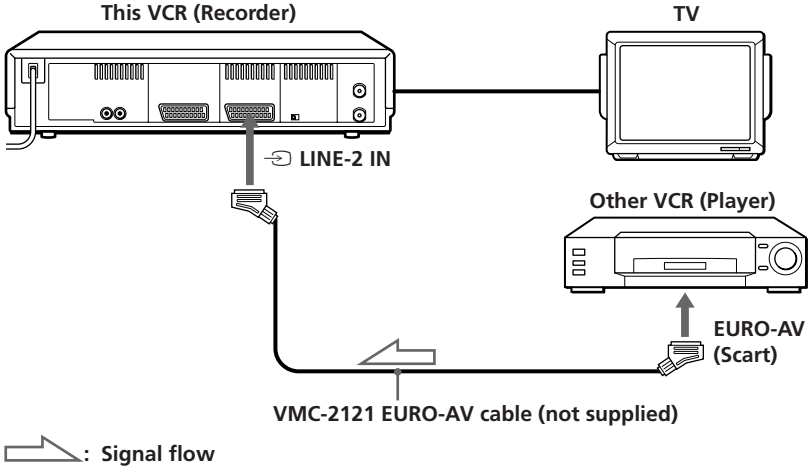

Tip

- You can also use the LINE-1 (TV) connector instead.

Note

- If the other VCR doesn't have a EURO-AV (Scart) connector, use the VMC-2106 cable instead and connect the cable to the line out jacks of the other VCR.

continued

Editing with another VCR (continued)

Operation (when recording on this VCR)

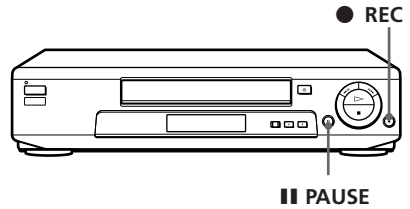

Before you start editing

- Turn on your TV and set it to the video channel.
- Press INPUT SELECT to display “L2” (or “L1”) in the display window.
- Press SP/LP to select the tape speed, SP or LP.
- On this VCR, set EDIT in the VIDEO OPTIONS menu to ON. If the other VCR has a similar function, turn it on also.

- 1** Insert a source tape with its safety tab removed into the other (playback) VCR. Search for the point to start playback and set it to playback pause.
- 2** Insert a tape with its safety tab in place into this (recording) VCR. Search for the point to start recording and press **■ PAUSE**.
- 3** Press **● REC** on this VCR to set it to recording pause.
- 4** To start editing, press the **■ PAUSE** buttons on both VCRs at the same time.

To stop editing

Press the **■ STOP** buttons on both VCRs.

Tips

- To edit more precisely, press the **■ PAUSE** buttons on the VCRs to release pause.
- To cut out unwanted scenes while editing, press **■ PAUSE** on this VCR when an unwanted scene begins. When it ends, press **■ PAUSE** again to resume recording (Assemble Editing).

Note

- If you start editing following the procedure above, the VCR won't start recording with the OPC function. To record a tape with the OPC function, press **● REC** again during recording pause in step 3 so the VCR analyses the tape. Then, when you start editing in step 4, press **■ PAUSE** after the OPC indicator stops flashing. If you press **■ PAUSE** before the OPC indicator stops flashing, the OPC function is cancelled.

Troubleshooting

If you have any questions or problems not covered below, please consult your nearest Sony service facility.

	Symptom	Remedy
Power	The ON/STANDBY switch does not function.	<ul style="list-style-type: none"> Connect the mains lead to the mains securely.
	The power is turned on but the VCR does not operate.	<ul style="list-style-type: none"> Moisture condensation occurs. Turn the power off, unplug the mains lead and leave the VCR to dry for over one hour.
Clock	The clock has stopped and “-:-” lights in the display window.	<ul style="list-style-type: none"> The clock stops if the VCR is disconnected from the mains for more than one hour. Reset the clock (and timer).
	The playback picture does not appear on the TV screen.	<ul style="list-style-type: none"> Make sure the TV is set to the video channel. If you are using a monitor, set it to video input. If the VCR is connected to the TV only with the aerial cable, make sure that RF MODULATOR in the OPTIONS menu is set to ON.
Playback	The picture is not clear.	<ul style="list-style-type: none"> Adjust the tracking with the TRACKING +/- buttons. The video heads are dirty (see below). Clean the video heads using the Sony T-25CLD, E-25CLDR, or T-25CLW video head cleaning cassette. If these cleaning cassettes are not available in your area, have the heads cleaned at your nearest Sony service facility (a standard service charge will be required). Do not use a commercially available liquid type cleaning cassette other than Sony's, as it may damage the video heads. The video heads may have to be replaced. Consult your local Sony service facility for more information.

Symptoms caused by contaminated video heads

- Normal picture
- Rough picture
- Unclear picture
- No picture (or black & white screen appears)

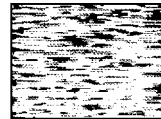
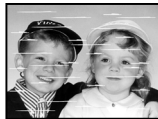

initial contamination



terminal

continued

Troubleshooting (continued)

	Symptom	Remedy
Playback	The picture rolls vertically during picture search.	<ul style="list-style-type: none"> Adjust the vertical hold control on the TV or monitor.
	The picture has no sound.	<ul style="list-style-type: none"> The tape is defective. Use a new tape.
	The sound is unstable or has an echo.	<ul style="list-style-type: none"> When you play a tape with the same sound recorded on both the hi-fi and normal sound tracks, make sure AUDIO MIX in the OPTIONS menu is set to OFF.
Recording	No TV programme appears on the TV screen.	<ul style="list-style-type: none"> Make sure the TV is set to the video channel. If you are using a monitor, set it to video input. If the VCR is connected to the TV using only the aerial cable, make sure that RF MODULATOR in the OPTIONS menu is set to ON.
	TV reception is poor.	<ul style="list-style-type: none"> Adjust the TV aerial.
	The tape starts playing as soon as it is inserted.	<ul style="list-style-type: none"> The safety tab has been removed. To record on this tape, cover the tab hole.
	The tape is ejected when you press ● REC.	<ul style="list-style-type: none"> Check that the safety tab has not been removed.
	Nothing happens when you press ● REC.	<ul style="list-style-type: none"> Make sure the tape is not at its end. Select the correct source with the INPUT SELECT button. Select a programme position when recording TV programmes; select "L1" or "L2" when recording from other equipment.
Timer recording	The timer does not operate.	<ul style="list-style-type: none"> Check that the clock is set. Make sure a tape has been inserted. Check that the safety tab has not been removed. Make sure the tape is not at its end. Make sure a programme has been set for timer recording. Make sure your timer settings have not already passed the current time. Check that the satellite tuner is turned on. The clock stops if the VCR is disconnected from the mains for more than one hour. Reset the clock and timer.

	Symptom	Remedy
Others	A tape cannot be inserted.	<ul style="list-style-type: none"> • Check that a tape isn't already in the tape compartment.
	The remote commander does not function.	<ul style="list-style-type: none"> • Make sure you are pointing the remote commander at the remote sensor on the VCR. • Replace all the batteries in the remote commander with new ones if they are weak. • Make sure the [TV]/[VIDEO] remote control switch is set correctly.
	The tracking meter does not appear on the TV screen.	<ul style="list-style-type: none"> • The recording condition of the tape is very poor and tracking cannot be adjusted. • The tracking meter does not appear when playing back an NTSC-recorded tape.
	You cannot control other TVs.	<ul style="list-style-type: none"> • Set your TV's code number. The code number resets to 01 when you replace the batteries of the remote commander.
	The VCR needs to be cleaned.	<ul style="list-style-type: none"> • Clean the cabinet, panel and controls with a dry, soft cloth, or a soft cloth slightly moistened with a mild detergent solution. Do not use any type of solvent, such as alcohol or benzine.
	The SECURITY FUNCTION menu doesn't appear on the TV screen.	<ul style="list-style-type: none"> • Once you enter your personal code, you cannot change it by yourself. If you need to change the entered personal code, consult your nearest Sony service facility (a standard service charge will be required).

Specifications

System

Channel coverage

PAL (I)

VHF IA to IJ, SA10 to SA13 (SLV-E730EX only)

UHF B21 to B69

CATV S01 to S05, S1 to S20 (SLV-E730EX only)

HYPER S21 to S41 (SLV-E730EX only)

RF output signal

UHF channels 21 to 69

Aerial out

75-ohm asymmetrical aerial socket

Inputs and outputs

⇄ LINE-1 (TV)

21-pin

Video input: pin 20

Audio input: pins 2 and 6

Video output: pin 19

Audio output: pins 1 and 3

⇄ LINE-2 IN

21-pin

Video input: pin 20

Audio input: pins 2 and 6

AUDIO OUT

Phono jack (2)

Rated output level: 327 mVrms

Load impedance: 47 kilohms

Output impedance: less than 10 kilohms

General

Power requirements

220 – 240 V AC, 50 Hz

Power consumption

23 W

Operating temperature

5°C to 40°C

Storage temperature

-20°C to 60°C

Dimensions

Approx. 430 × 100 × 314 mm

(Approx. 17 × 4 × 12³/₈ inches) (w/h/d)

including projecting parts and controls

Mass

Approx. 4.6 kg (Approx. 10 lb 22 oz)

Supplied accessories

Remote commander (1)

R6 (size AA) batteries (2)

Aerial cable (1)

Design and specifications are subject to change without notice.

Index to parts and controls

Refer to the pages indicated in parentheses () for details.

Front panel

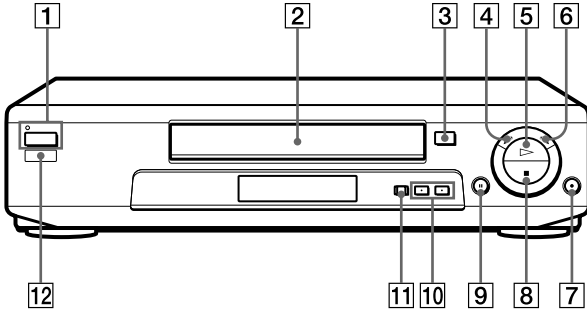

- | | |
|---|---|
| 1 ON/STANDBY switch/indicator (26) | 8 ■ STOP button (54) |
| 2 Tape compartment | 9 ■ PAUSE button (54) |
| 3 ≡ EJECT button (29) | 10 PROGRAM/TRACKING +/- buttons (13, 42, 49) |
| 4 ◀◀⏮ REW (rewind) button (41) | 11 AUTO SET UP/ RF (Radio Frequency) CHANNEL button (11, 12) |
| 5 ▷▶▶▶ PLAY button (41) | 12 Remote sensor (5) |
| 6 ▶▶▶▶ FF (fast-forward) button (41) | |
| 7 ● REC (record) button (54) | |

continued

Index to parts and controls (continued)

Display window

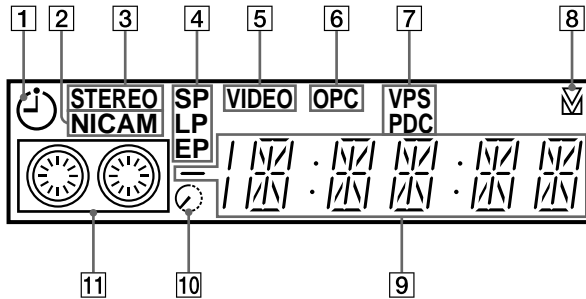

- 1 Timer indicator (36, 39)
- 2 NICAM indicator (46)
- 3 STEREO indicator (46)
- 4 Tape speed indicators (32)
- 5 VIDEO indicator (10, 33)
- 6 OPC (Optimum Picture Control) indicator (49)
- 7 VPS (Video Programme System)/PDC (Programme Delivery Control) indicator (37)
- 8 Tracking indicator (49)
- 9 Time counter/clock/line/programme position indicator (30, 32, 54)
- 10 Remaining time indicator (33)
- 11 Tape/recording indicator (30, 32)

Rear panel

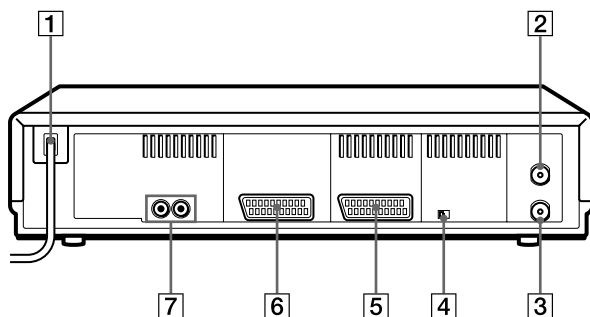

- | | |
|---|--|
| 1 Mains lead (9) | 5 ↪ LINE-2 IN connector (53) |
| 2 AERIAL OUT
ANTENNE SORTIE connector (9) | 6 ↪ LINE-1 (TV)
↪ LIGNE-1 (TV) connector (10, 21) |
| 3 AERIAL IN
ANTENNE ENTREE connector (9) | 7 AUDIO OUT R (right)/L (left)
SORTIE AUDIO D/G jacks (10) |
| 4 NTSC PB (Play Back) switch (29) | |

continued

Index to parts and controls (continued)

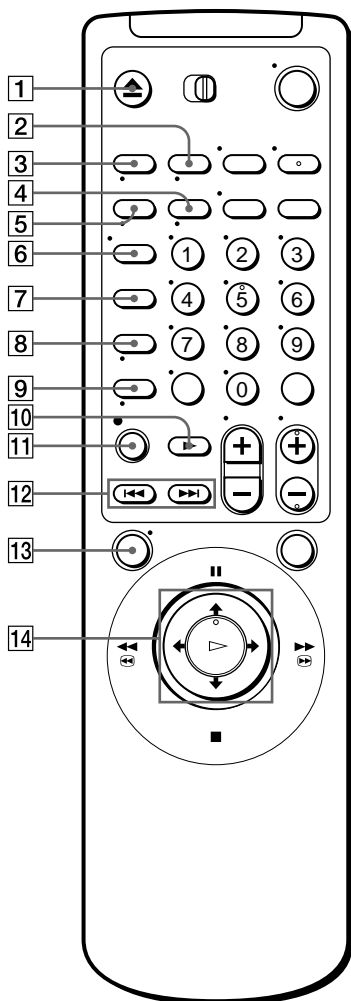

Remote commander

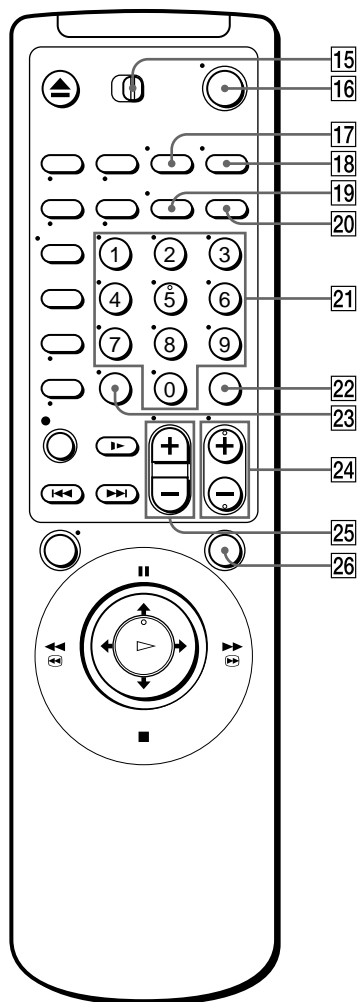

- 1 ▲ EJECT button (29)
- 2 COUNTER/REMAIN button* (33)
- 3 COUNTER RESET button* (30)
- 4 × 2 button* (41)
- 5 CLEAR button* (21, 36, 45)
- 6 DISPLAY button (33)
- 7 QUICK TIMER button (43)
- 8 INPUT SELECT button (32, 39)
 - TV power on/TV mode select button (for TV) (6)
- 9 SP (Standard Play)/LP (Long Play) button (32)
 - ☰ (Teletext) button (for TV) (6)
- 10 ►► SLOW button (41)
- 11 ● REC (record) button (32)
- 12 ◀◀/▶▶ INDEX SEARCH buttons (48)
- 13 MENU button (14, 38, 44, 51)
- 14 Joystick (14, 29, 41)
 - ↑/↓/←/→/
 - || PAUSE/■ STOP/
 - ◀◀ REW (rewind)/
 - ▶▶ FF (fast-forward)/
 - ▷ PLAY/OK

* FASTTEXT buttons (for TV)



- 15 TV/VIDEO remote control switch (5)
 - 16 ON/STANDBY switch (6, 36)
 - 17 WIDE button (*for TV*) (7)
 - 18 AUDIO MONITOR button (46)
 - 19 TV/VIDEO button (10, 33)
 - 20 VIDEO Plus+ button (35)
 - 21 Programme number buttons (6, 16, 19, 34)
 - 22 SET button (36)
 - 23 --- (ten's digit) button (34)
 - 24 PROG (programme) +/- buttons (6, 16, 32)
 - 25 VOL (volume) +/- buttons (*for TV*) (6)
 - 26 REPLAY button (29)
-  /  Teletext page access buttons (*for TV*) (7)

Index

A, B

- Accessories supplied 4
- Adjusting
 - picture 17, 42, 49
 - tracking 42, 49
- Aerial hookup 9
- AFT (Auto Fine Tuning) 17
- ATP (Auto Tuner Preset) 11
- Audio track 47
- Auto Clock Set 24
- Auto Set Up 11
- Auto Tape Speed 51

C

- Cleaning the video heads 55
- Clock setting 22
- Colour system
 - compatible colour systems 2
 - setting 29
- Connecting
 - the VCR and your TV 9
 - to a stereo system 10
 - to a TV with a EURO-AV connector 10
- Counter 30

D

- Disabling programme position 17
- Dubbing. *See* Editing

E, F

- Editing 53
- EP mode 30
- EURO-AV connection 10

G

- Guide channel setting 18

H

- Hi-fi audio track 47

I, J, K

- Index
 - searching 48

L

- Language selecting 14
- LP mode 32

M

- Monitoring
 - during playback 47
 - during recording 46

N

- NICAM broadcasts 46
- Normal audio track 47

O

- OPC (Optimum Picture Control) 49

P

- PDC (Programme Delivery Control) 37
- Picture adjustment. *See* Adjusting
- Playback 28
 - at various speeds 29, 41
 - frame-by-frame 41
 - slow motion 41
- Power save 52
- Presetting channels 11, 15

Q

- Quick timer 43

R

- Recording 31
 - bilingual programmes 46
 - saving 33
 - stereo programmes 46
 - using VIDEO Plus+ 35
 - while watching another programme 33
- Remote commander 5
- RF channel 12

S

- Safety tab 33
- Searching
 - at various speeds 41
 - using the index function 48
- SP mode 32

T, U

- Timer recording 35, 38
 - cancelling timer settings 44
 - changing timer settings 44
 - checking timer settings 44
 - daily/weekly recording 37, 40
 - overlapping timer recordings 45
 - using VIDEO Plus+ 35
- Tracking adjustment. *See* Adjusting

V, W, X, Y, Z

- VIDEO Plus+
 - recording 35
 - setting up 18
- VPS (Video Programme System) 37